

Towards Subjectivity in Annual Climate-Based Daylight Metrics

J. Alstan Jakubiec¹

asd.sutd.edu.sg/dcc
spectraldb.com

john_jakubiec@sutd.edu.sg

Geraldine Quek^{1,2}

Thanyalak Srisamranrungruang^{1,3}

1. Singapore University of Technology and Design
2. École Polytechnique Fédérale de Lausanne
3. Meiji University

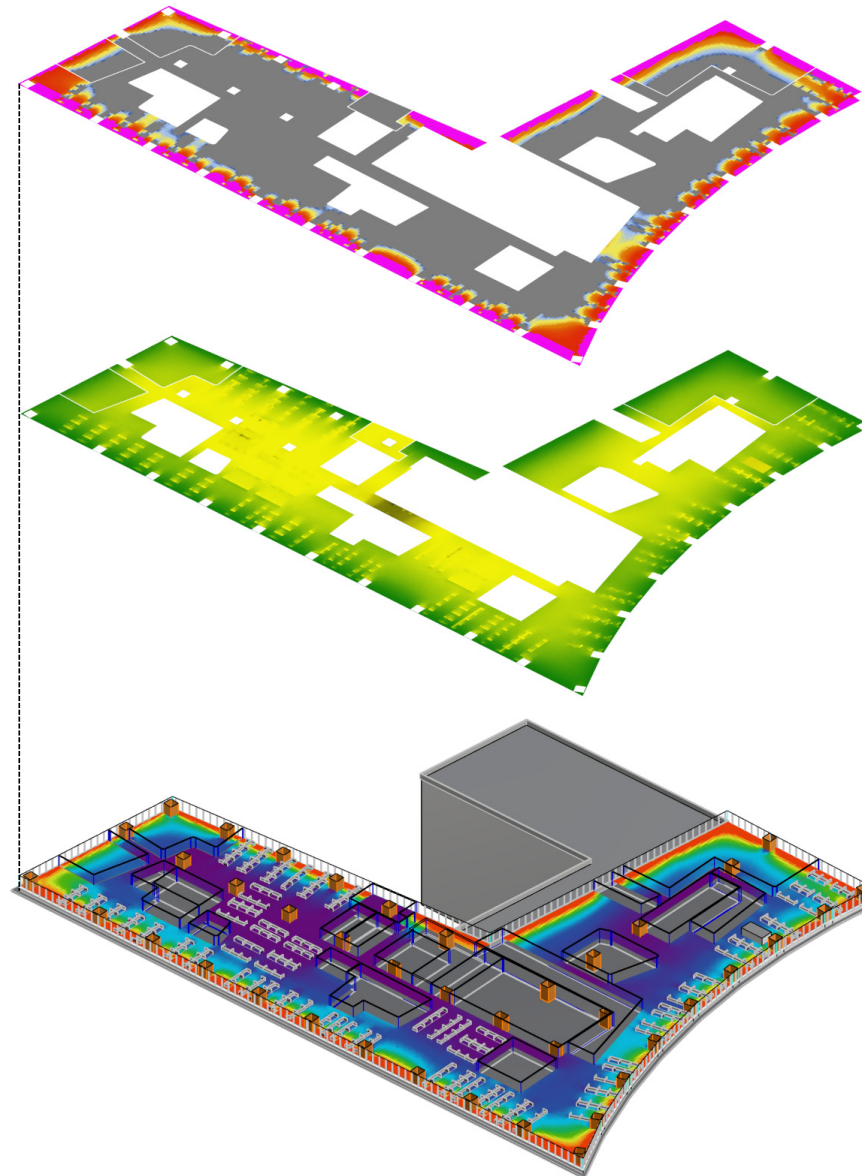

Current Green Mark Criteria
% Occupied Hours \geq 500 lx

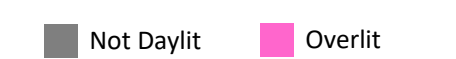

23.5% of Space Fully Daylit
13.4% of Space Overlit (Needs Shades)

Percent of Occupants Satisfied
with Access to Daylight

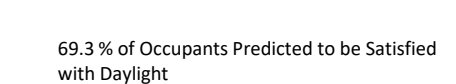

Average Daytime Illuminance (lx)

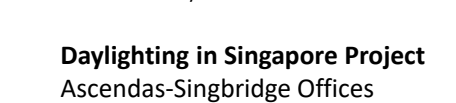

Daylighting in Singapore Project
Ascendas-Singbridge Offices



A (Very) Brief Introduction to Climate-Based Daylight Modelling

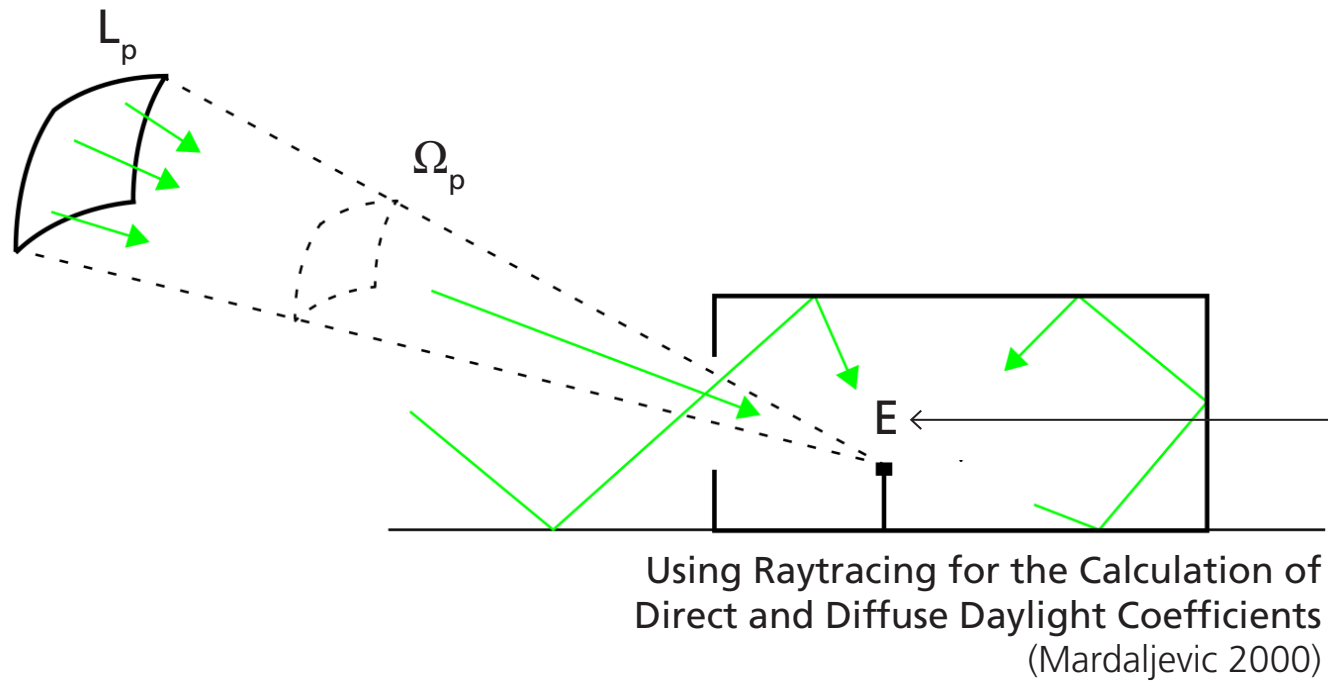

- Consider raytracing to many sky patches, which may contribute to illuminance at a point by direct or interreflected contribution.
- The illuminance E at the point is simply the sum of these contributions, Daylight Coefficients, multiplied by their solid angle Ω and their luminance L .

$$E = \sum_{patch=1}^{n_{divisions}} DC_p \cdot \Omega_p \cdot L_p$$

↑
Illuminance of Point
↑
Daylight Coefficient
Corrected for Cosine
↑
Solid Angle of Patch
↑
Luminance Patch



A (Very) Brief Introduction to Climate-Based Daylight Modelling

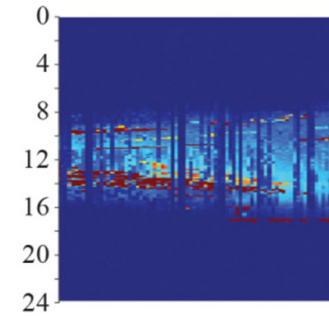
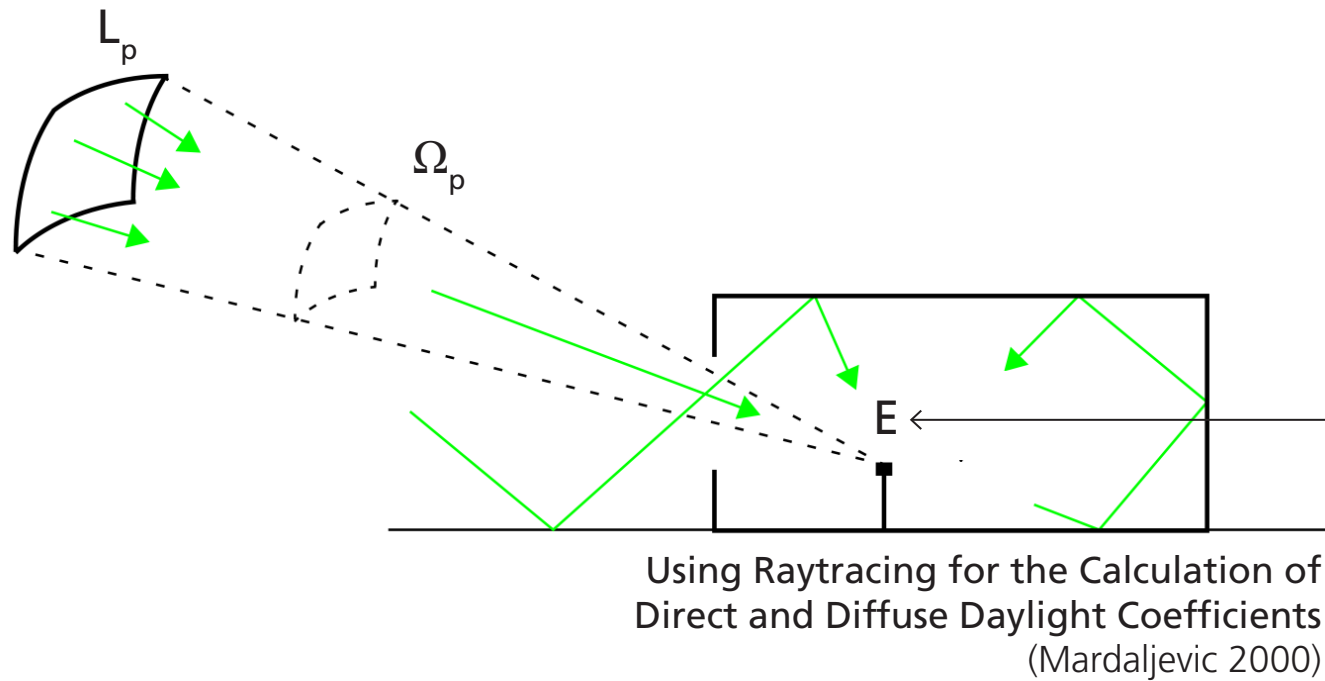

8760 x

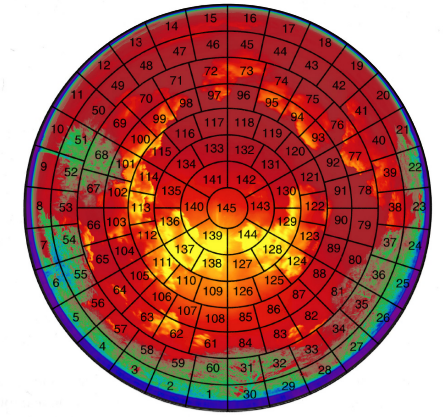

$$E = \sum_{patch=1}^{n_{divisions}} DC_p \cdot \Omega_p \cdot L_p$$

Illuminance of Point \uparrow DC_p \uparrow Ω_p \uparrow L_p
 Daylight Coefficient Corrected for Cosine Solid Angle of Patch Luminance Patch

- Consider raytracing to many sky patches, which may contribute to illuminance at a point by direct or interreflected contribution.
- The illuminance E at the point is simply the sum of these contributions, Daylight Coefficients, multiplied by their solid angle Ω and their luminance L.
- Annual sky models through weather tapes or HDR measurements, allows very fast calculations of annual illuminance. This can also be extended to annual luminance renderings with a "little" work.



A question.

What do we do with these annual results?



Interpreting CBDM's Using a Frequency Basis

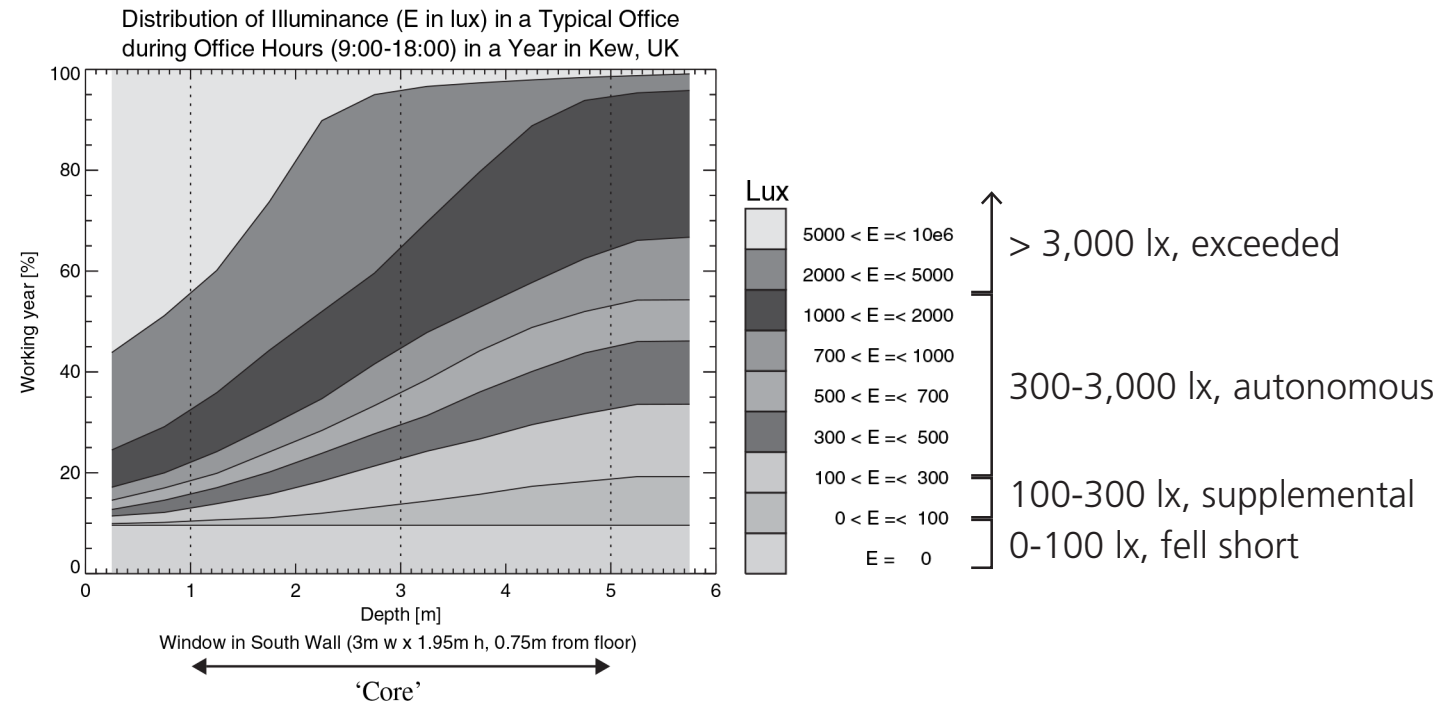

Useful Daylight Illuminances (UDI)

(Nabil and Mardaljevic 2005; Mardaljevic, Andersen, Roy, Christoffersen 2012)

Four discrete bins of illuminance based on the frequency of occurrence during a specific time period.

- fell short (minimize) 0-100 lx
- supplemental 100-300 lx
- autonomous (maximize) 300-3,000 lx
- exceeded (minimize) > 3,000 lx



Interpreting CBDM's Using a Frequency Basis

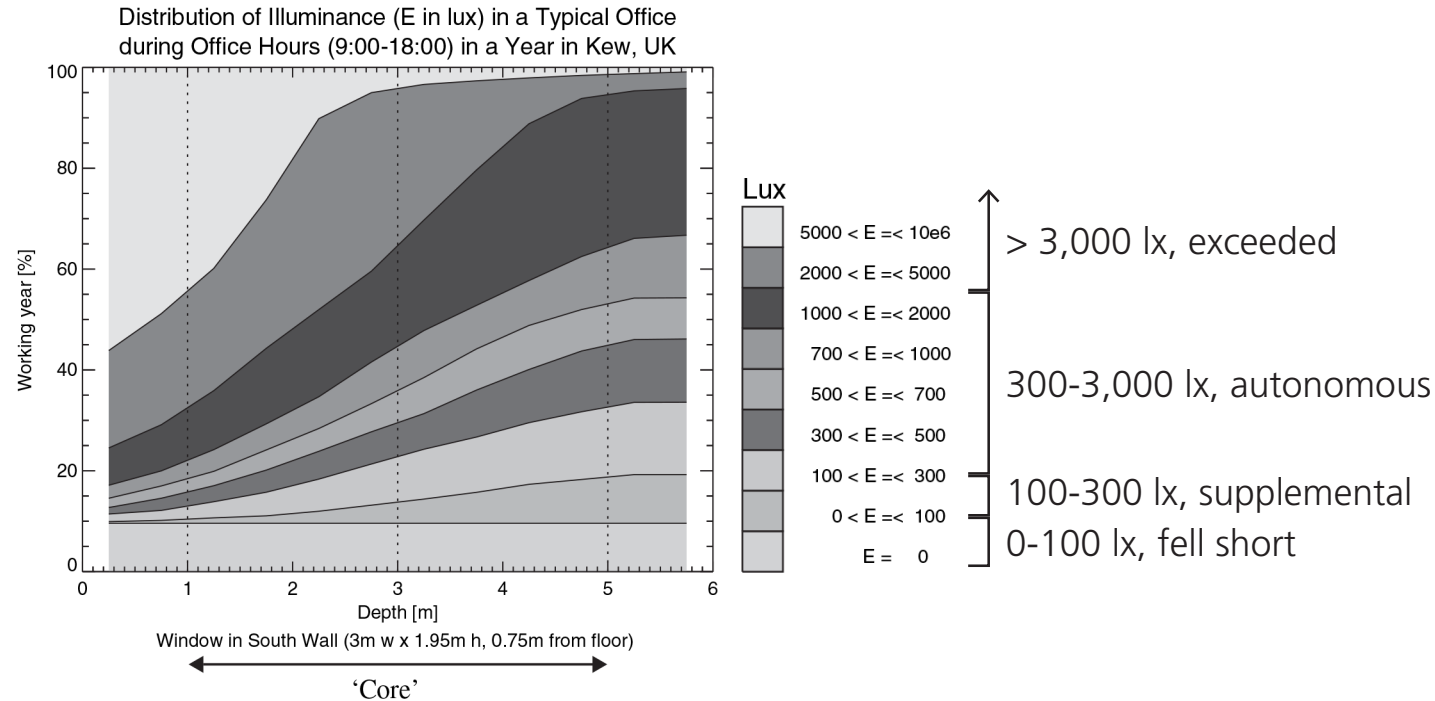

Useful Daylight Illuminances (UDI)

(Nabil and Mardaljevic 2005; Mardaljevic, Andersen, Roy, Christoffersen 2012)

Four discrete bins of illuminance based on the frequency of occurrence during a specific time period.

- fell short (minimize) 0-100 lx
- supplemental 100-300 lx
- autonomous (maximize) 300-3,000 lx
- exceeded (minimize) > 3,000 lx

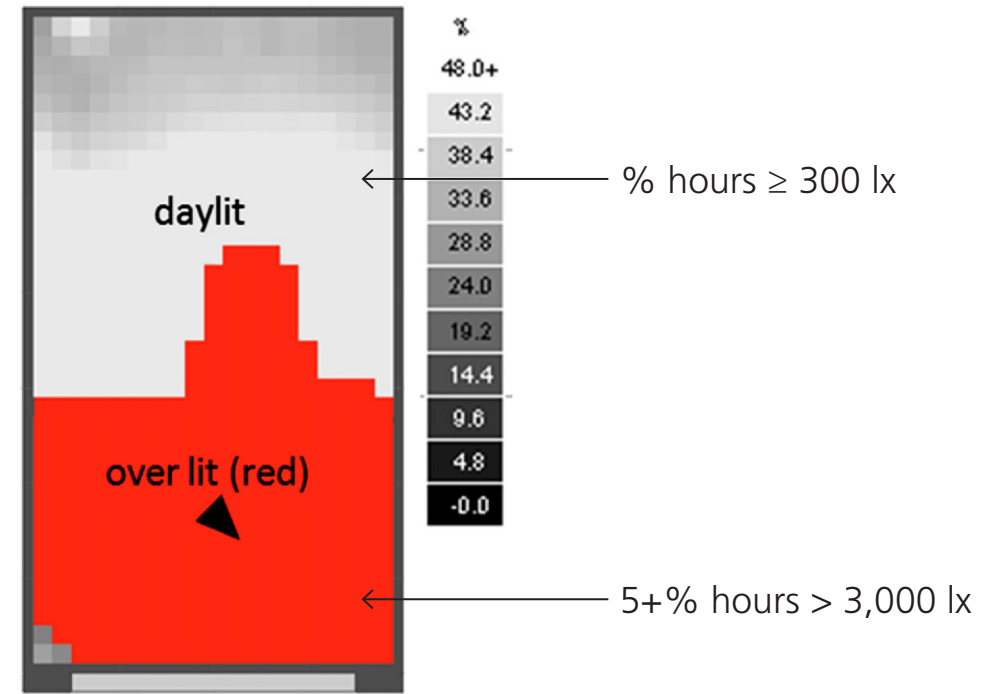

Daylight Availability (DAvail)

(Reinhart and Wienold 2010)

Combines frequency of achieving target lighting level with an overlighting provision.

- daylit autonomy: occupied time an illuminance target is achieved by daylight alone
- overlit: area where 10-times the target illuminance is achieved for more than 5% of occupied hours



Interpreting CBDM's Using a Frequency Basis

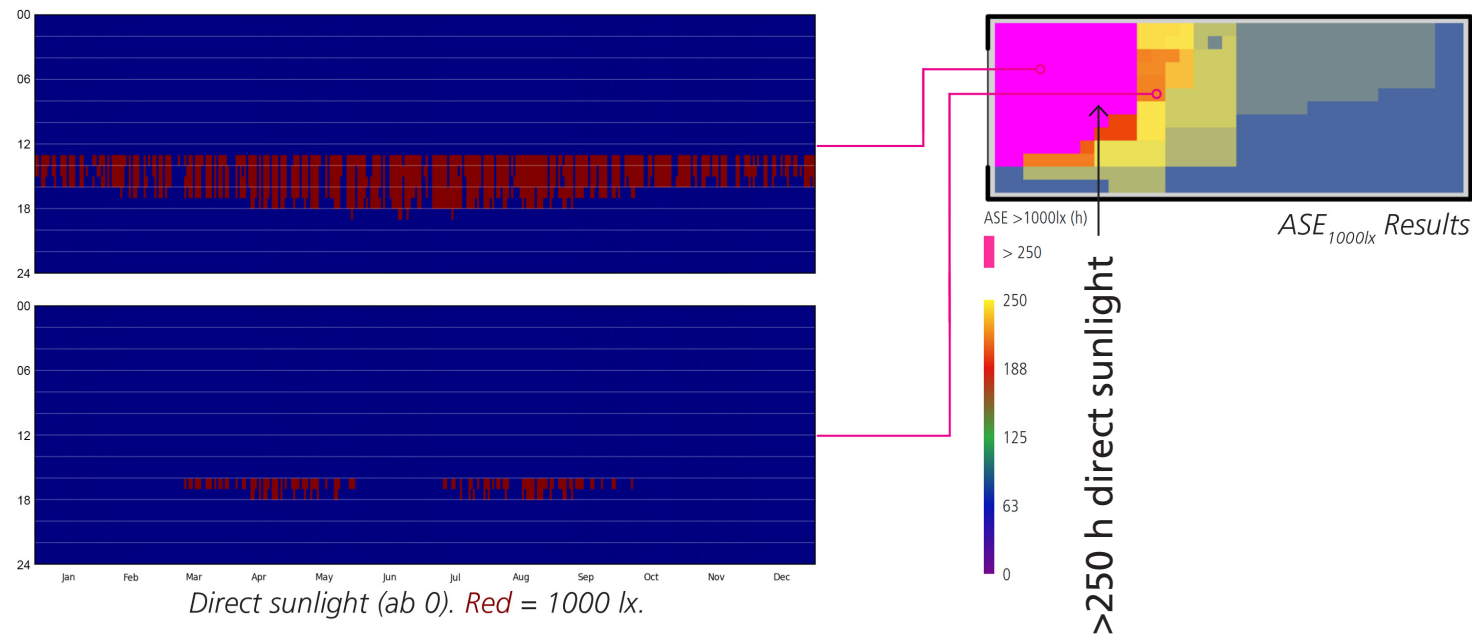

Annual Sunlight Exposure (ASE_{1000lx,250h})

(IES Daylight Metrics Committee, LM-83-12; Heschong 2012)

A pure overlighting measure due to direct sunlight in a specific climate. ASE has temporal and spatial recommendations for avoidance of visual discomfort.

- 250 h of direct sunlight is an indicator for comparing visual discomfort potential in spaces.
- >10% of space ASE_{1000lx,250h} - unsatisfactory
- <7% of space ASE_{1000lx,250h} - neutral
- <3% of space ASE_{1000lx,250h} - clearly acceptable

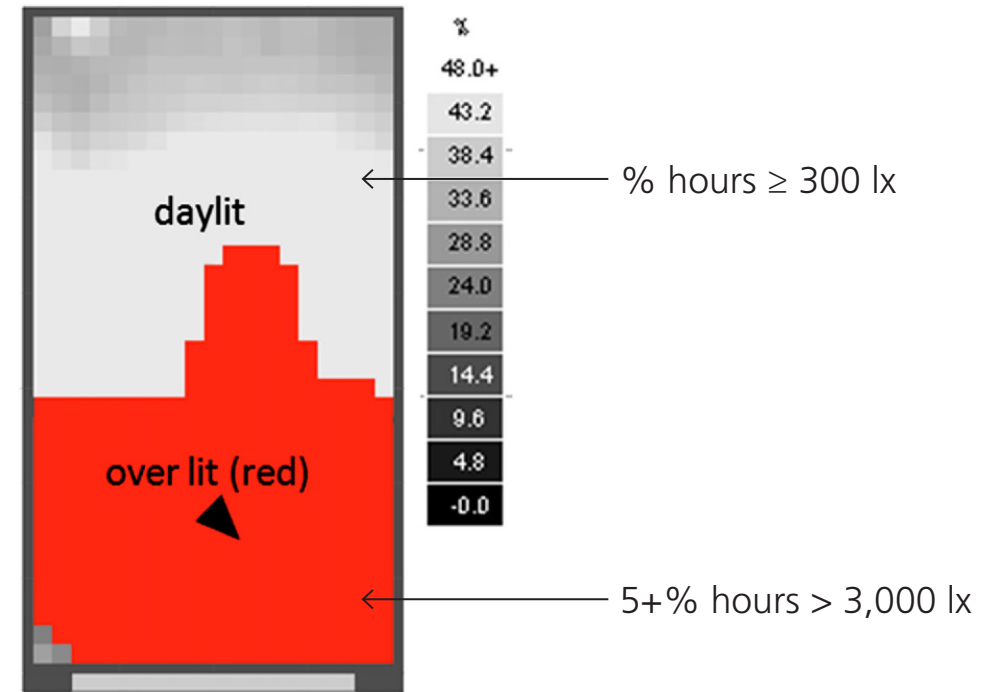

Daylight Availability (DAvail)

(Reinhart and Wienold 2010)

Combines frequency of achieving target lighting level with an overlighting provision.

- daylit autonomy: occupied time an illuminance target is achieved by daylight alone
- overlit: area where 10-times the target illuminance is achieved for more than 5% of occupied hours



Interpreting Subjective Results Using a Frequency Basis through CBDM

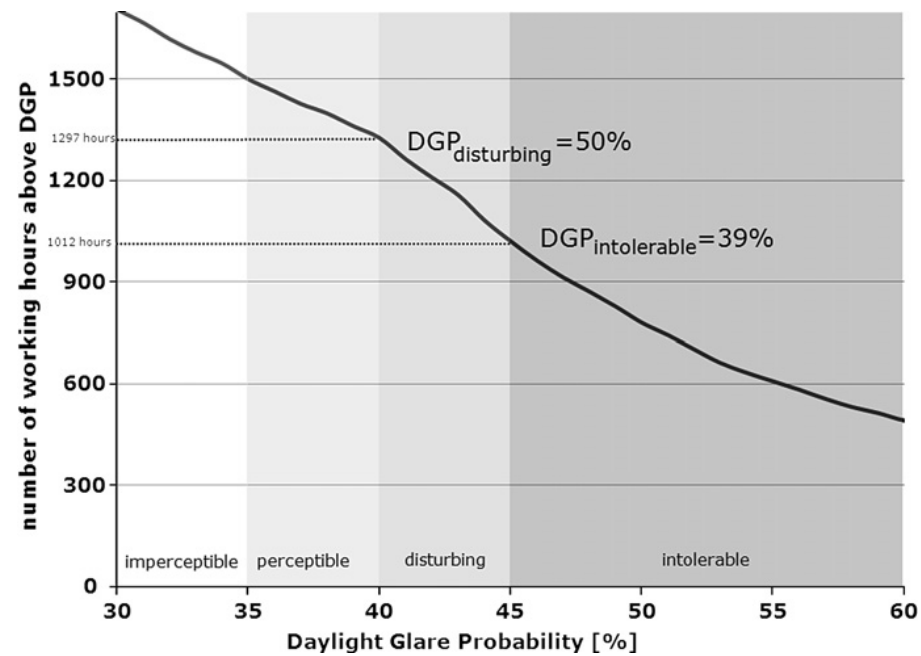

Enhanced Simplified Daylight Glare Probability (eDGPs)

(Wienold 2009)

Calculates the DGP visual discomfort measure annually by combining fast direct sunlight renderings and CBDM illuminance.

- Interpretation from thermal comfort standard EN-15251.
- Best class: $DGP \leq 0.35$ for 95% of occupied hours
- Good class: $DGP \leq 0.40$ for 95% of occupied hours
- Reasonable class: $DGP \leq 0.45$ for 95% of occupied hours



Interpreting Subjective Results Using a Frequency Basis through CBDM

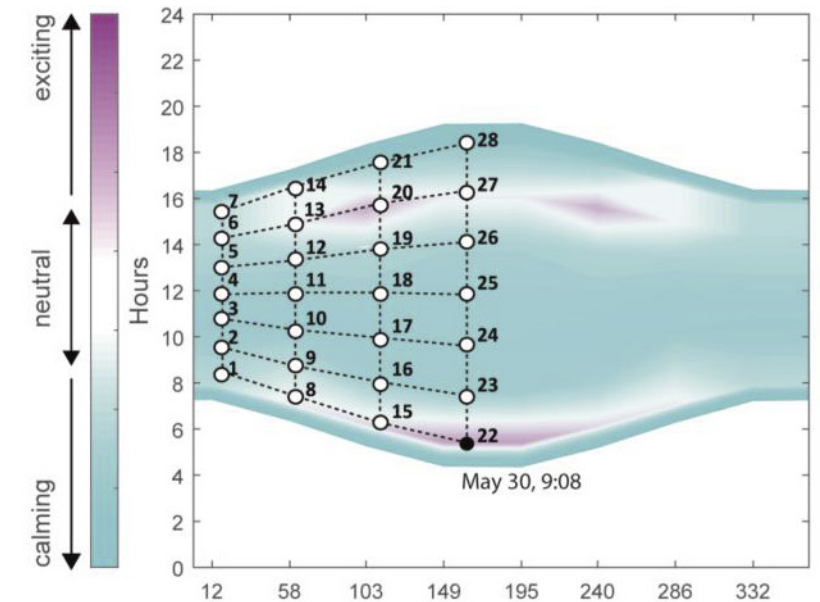
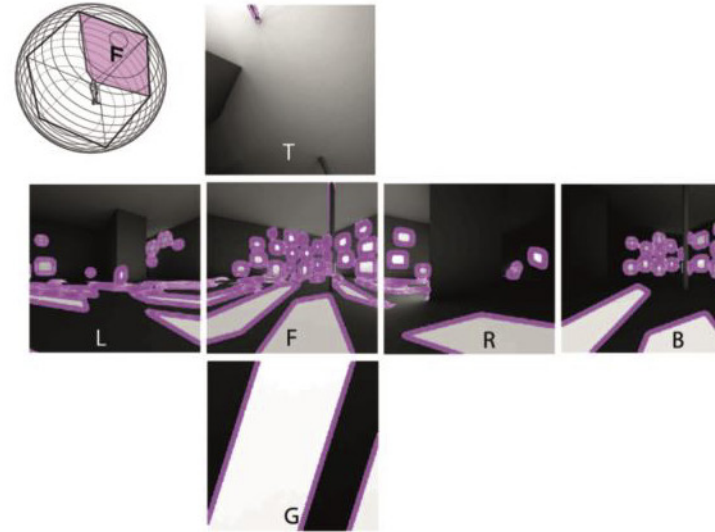
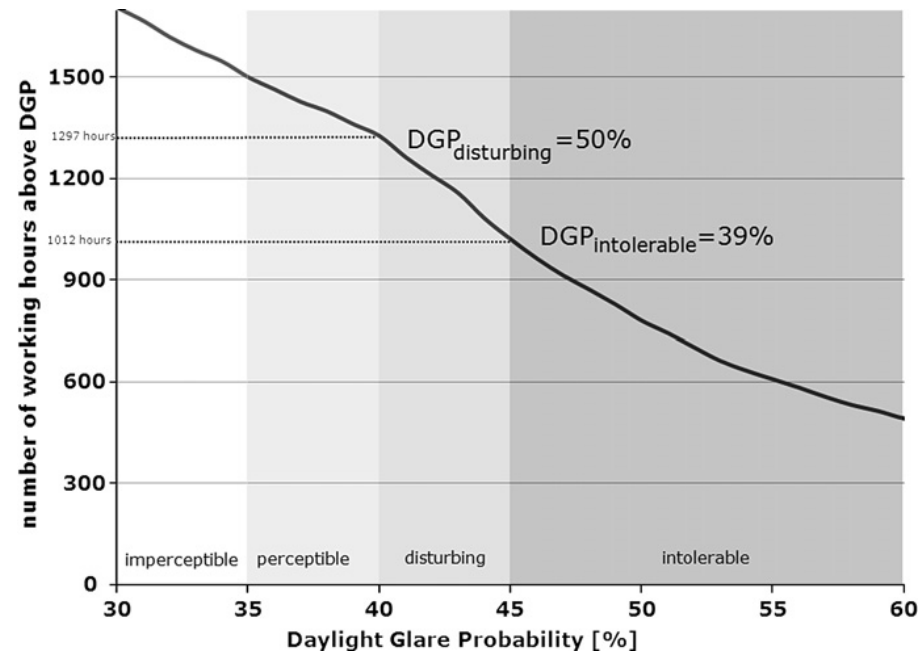

Enhanced Simplified Daylight Glare Probability (eDGPs)

(Wienold 2009)

Calculates the DGP visual discomfort measure annually by combining fast direct sunlight renderings and CBDM illuminance.

- Interpretation from thermal comfort standard EN-15251.
- Best class: $DGP \leq 0.35$ for 95% of occupied hours
- Good class: $DGP \leq 0.40$ for 95% of occupied hours
- Reasonable class: $DGP \leq 0.45$ for 95% of occupied hours

Modified Spatial Contrast (mSC)

(Rockcastle and Andersen 2014; Rockcastle, Chamilothoni, Andersen 2017)

Image contrast sampled at high and mid-resolutions was found to correlate with subjective impressions of “calming” and “exciting” on computer screens and in virtual environments.

- Bilinear interpolations across the year allows annual extrapolation of subjective impressions.
- Scenes tended to be ranked more ‘pleasant, interesting, and exciting’ with higher mSC values.



Moving Towards Subjectivity: Daylit Area

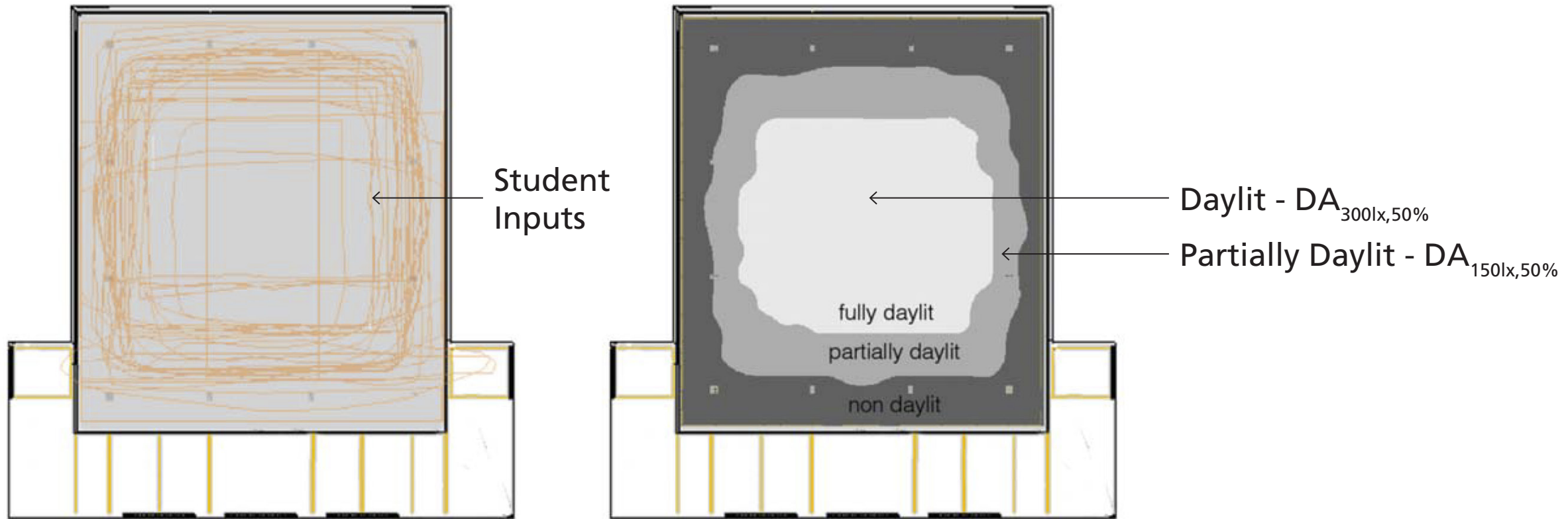

Daylit Area

(Reinhart and Weissman 2011; Reinhart, Rakha and Weissman 2014)

- Reinhart, et al. found that the area where 300 lx is achieved for 50% of the year ($DA_{300lx,50\%}$) happens to correlate with occupant impressions of what is daylit. 150 lx for 50% of the year ($DA_{150lx,50\%}$) tends to correlate with impressions of partially daylit.
- Based on surveys of 60 students in one building and validated using 331 student surveys in 13 spaces.



Moving Towards Subjectivity: Combined Annual Discomfort Index

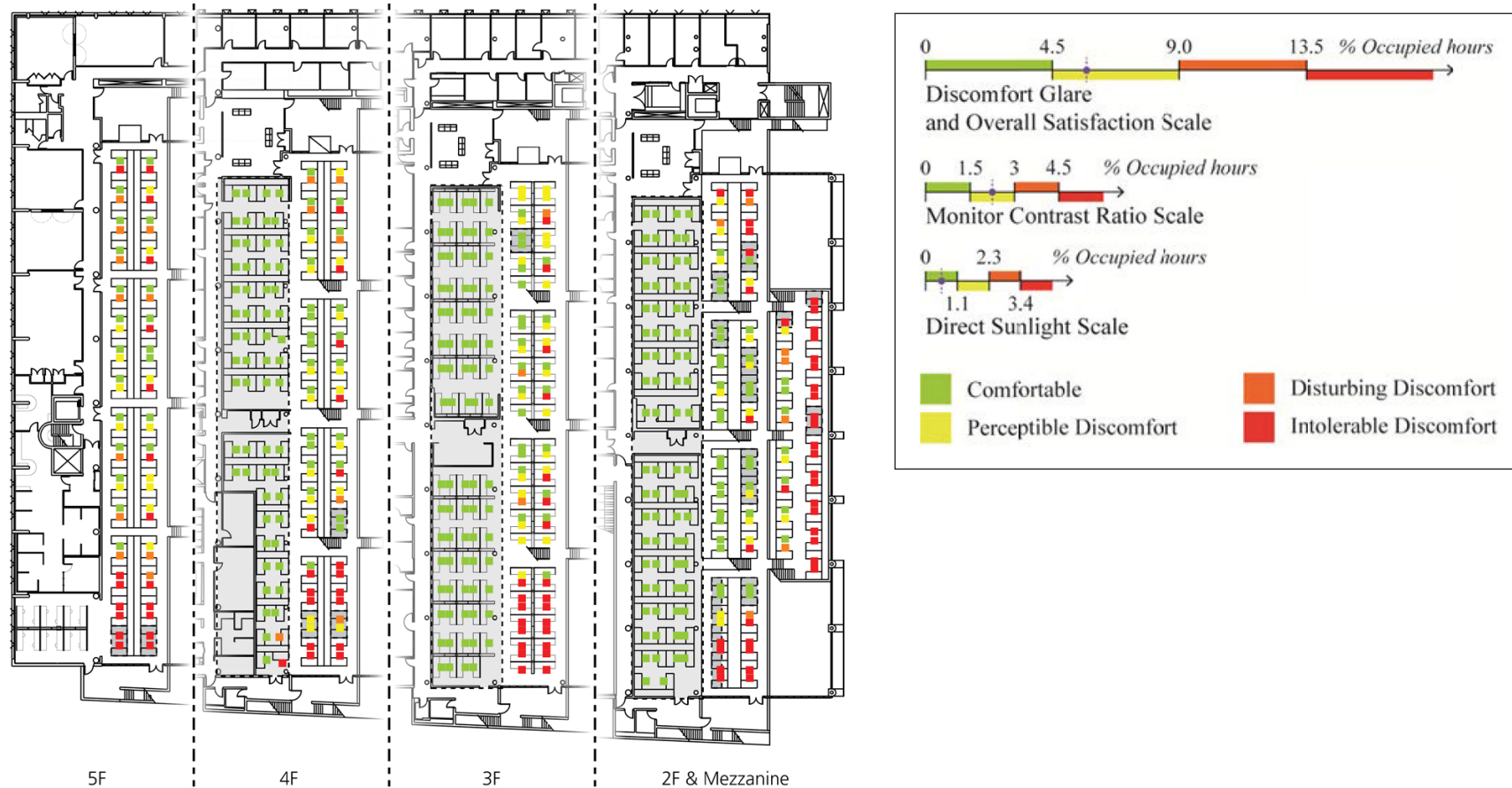

Combined Annual Discomfort Index

(Jakubiec and Reinhart 2013 & 2015)

- Theoretical long-term visual dissatisfaction metric based on 67 completed surveys from occupants in a daylight space and simulated frequency of occurrence of glare measures:
 - $DGP > 0.4$
 - Direct Sunlight on Eye or Desk $> 1,000$ lx
 - Monitor Contrast Ratio < 4

- Statistics were very, very bad, but the conclusions have some validity.



Research Goals

1. Search for subjective meaning in CBDM results beyond stating the frequency of occurrences.
2. Assess traditional lighting thresholds (300 lx, 500 lx) and visual discomfort metrics (UDI, UGR, DGP) in the field.

...

To achieve these, we needed to calculate CBDM's for real spaces using calibrated models and compare them to specific subjective responses.



Methodology



Building an Initial Daylighting Model from Space Measurements

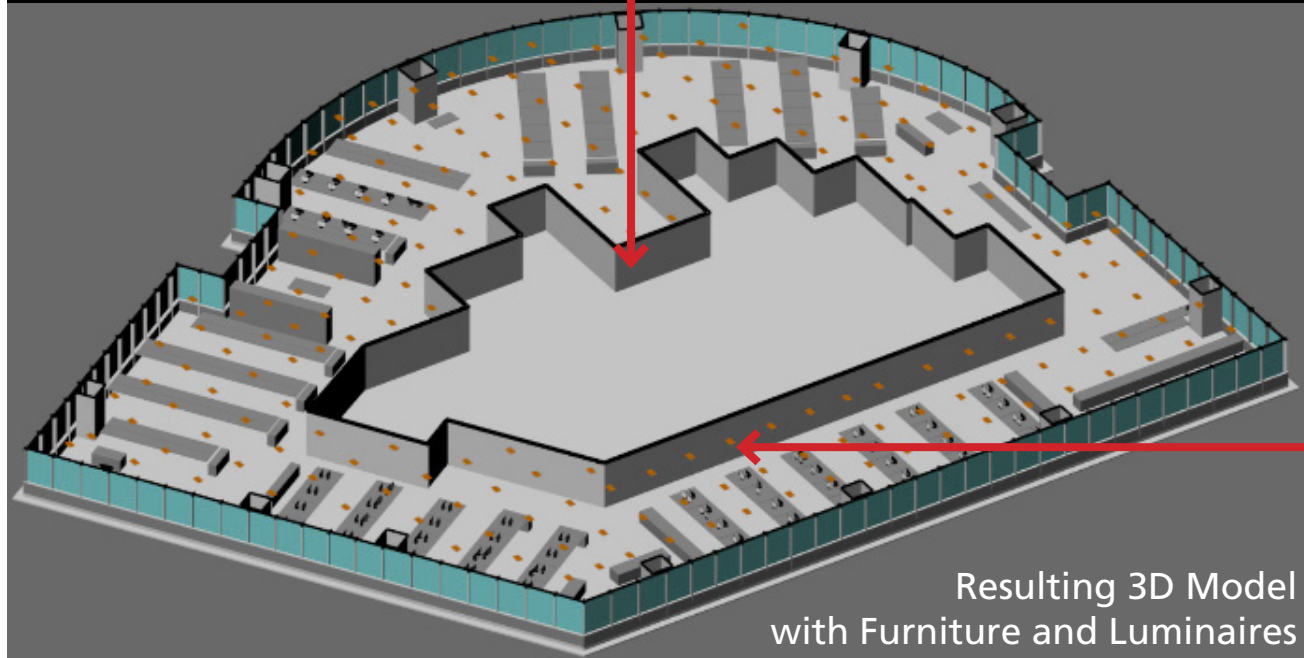
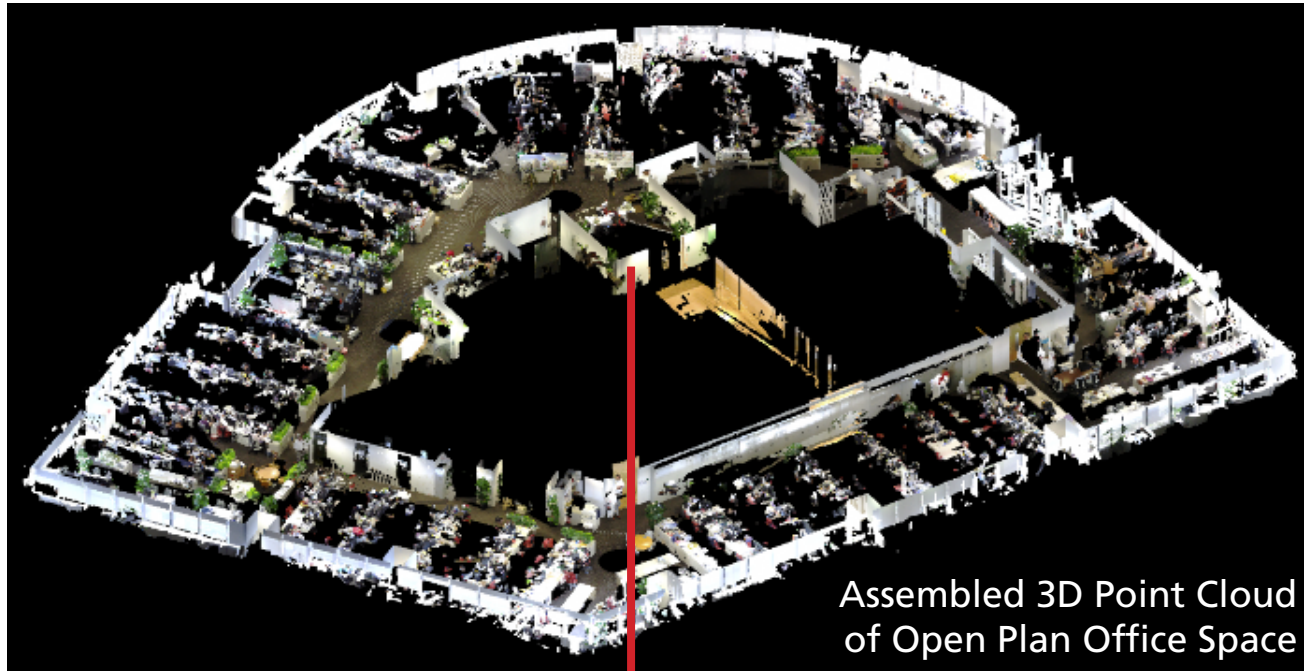

- Each office space is scanned into a point cloud format using a portable 3D scanner (Faro Focus X330).
- Opaque materials are measured using a sensor that records specular and diffuse spectrally-specific reflectance data (Konica Minolta 2600d).
- Glazing transmission data comes from specifications or through paired illuminance measurements.
- A 3D model including luminaire and monitor screen placement is constructed based on the 3D scan, and measured materials are applied using Radiance.

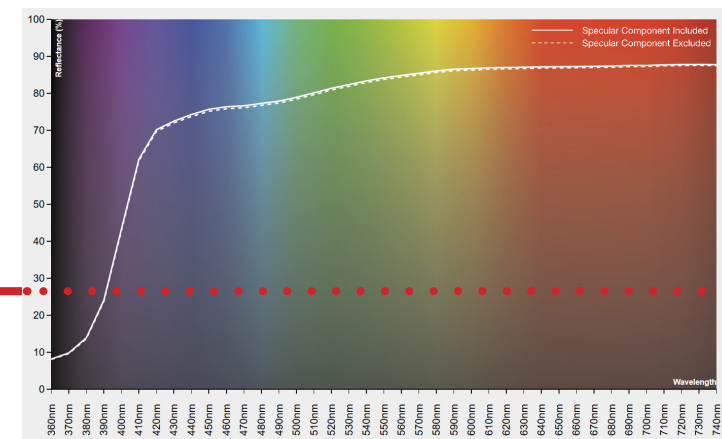

Instantaneous Lighting Measurements Paired with Survey

1. After completing a survey, occupants are asked to vacate their desk.
2. High dynamic range (HDR) luminance photograph paired with luminance measurement.
3. Vertical and horizontal illuminance measurements.

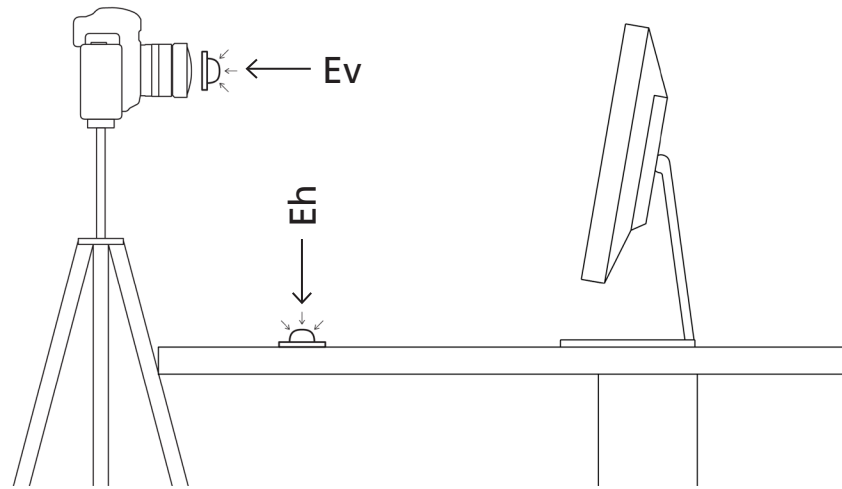

HDR Captured
Vertical and Horizontal Illuminance Recorded

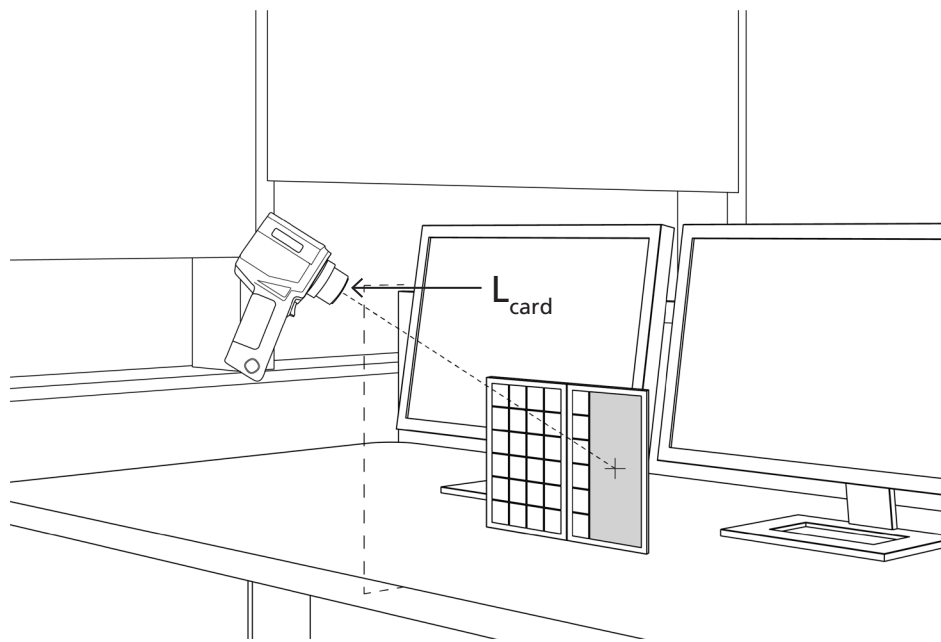

Luminance Measurements Recorded

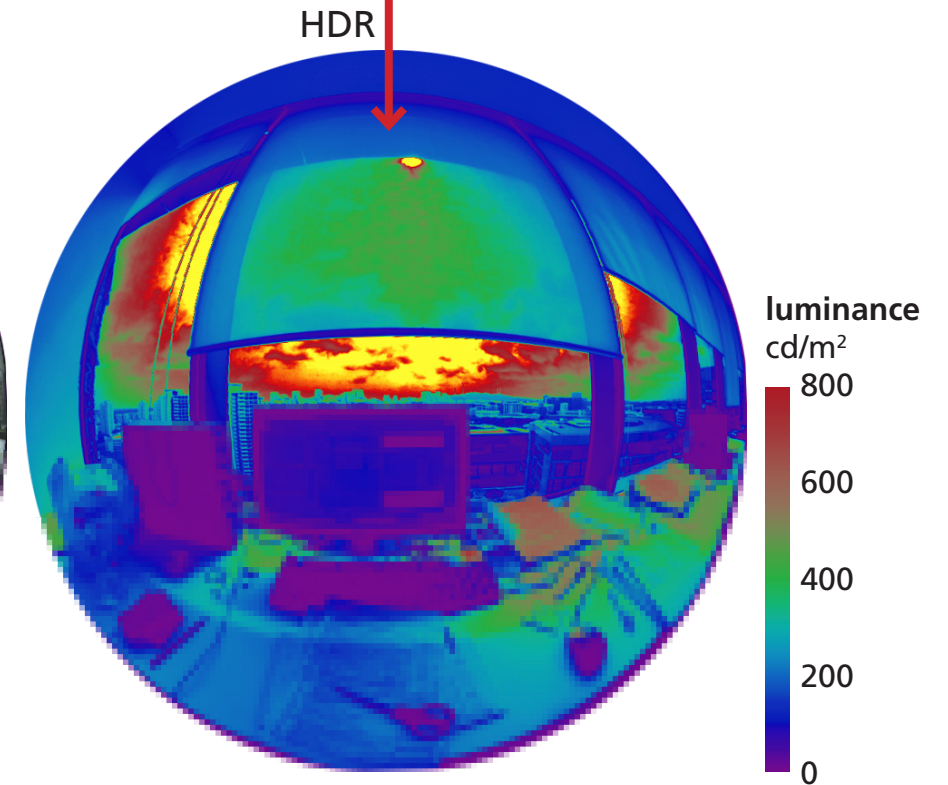

Example HDR Photograph Captured from Participant's
Point of View Immediately After Completing Survey



Electric Lighting Calibration

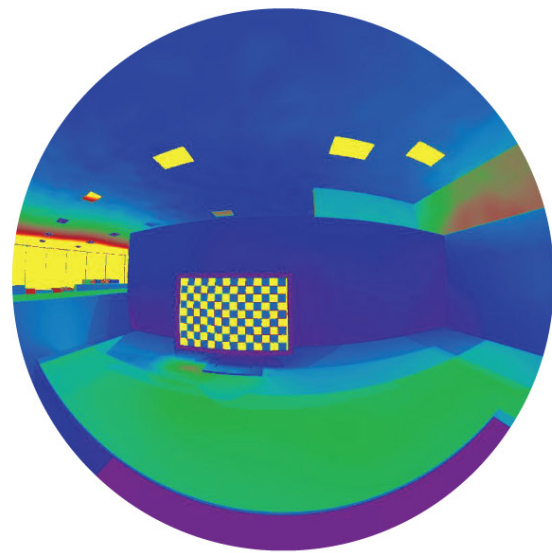

Luminaire Scaling Factor: 1

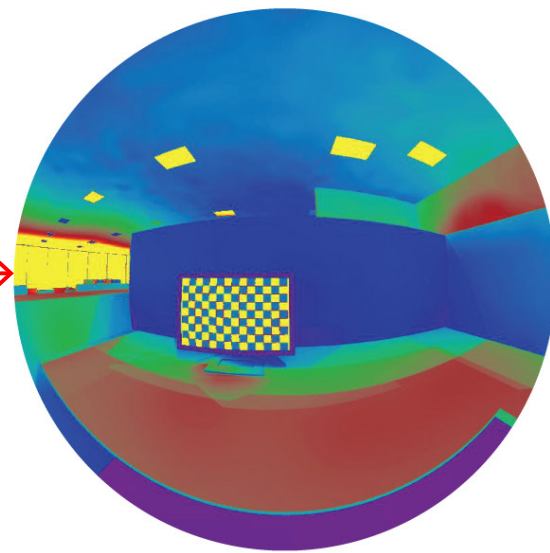

Luminaire Scaling Factor: 2

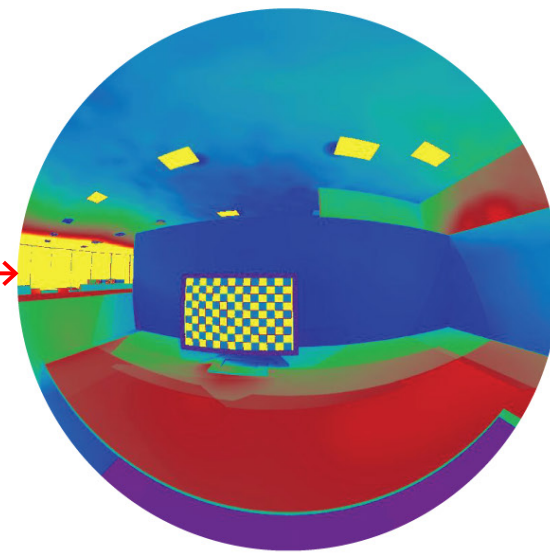

Luminaire Scaling Factor: 2.4

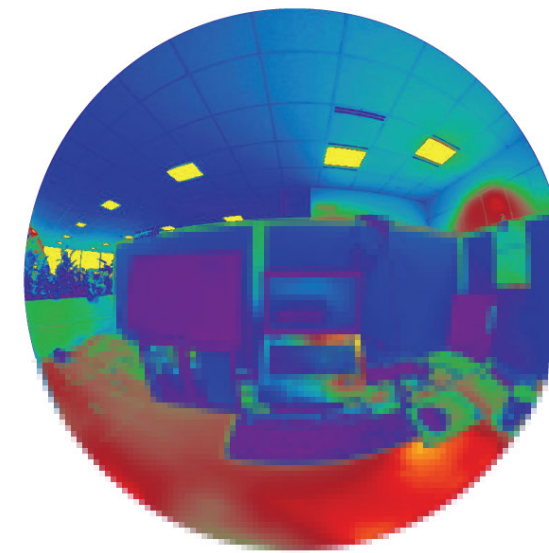

HDR Photograph

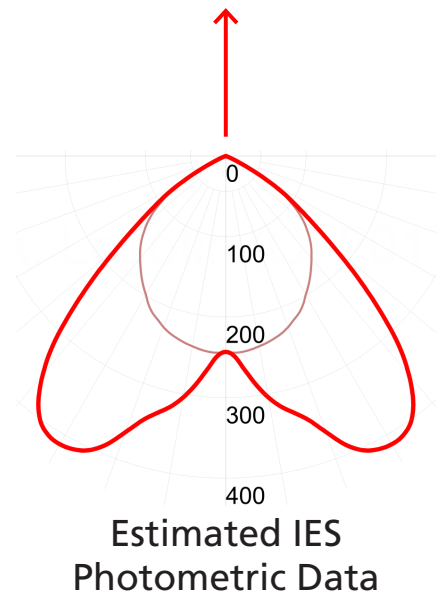

- Initially an IES file is chosen with a similar photometric distribution to what we can infer from HDR measurements.
- The intensity is gradually calibrated based on multiple HDR's captured at deep, interior parts of the floorplan with little access to daylight.



CBDM Simulation Process

- Vertical and horizontal illuminance is calculated at a 5-minute basis using the previous 365 days of weather data from the completion of an office survey.
- Measured global horizontal irradiance from our campus weather station is split using `gen_reind1`, and a custom 5 min `.wea` file is created for each building.
- Illuminance calculations are performed using Daysim.
- Radiance parameters:
`-ab 7 -ar 1000 -ad 2000 -as 500 -aa 0.1 -lw 0.02`

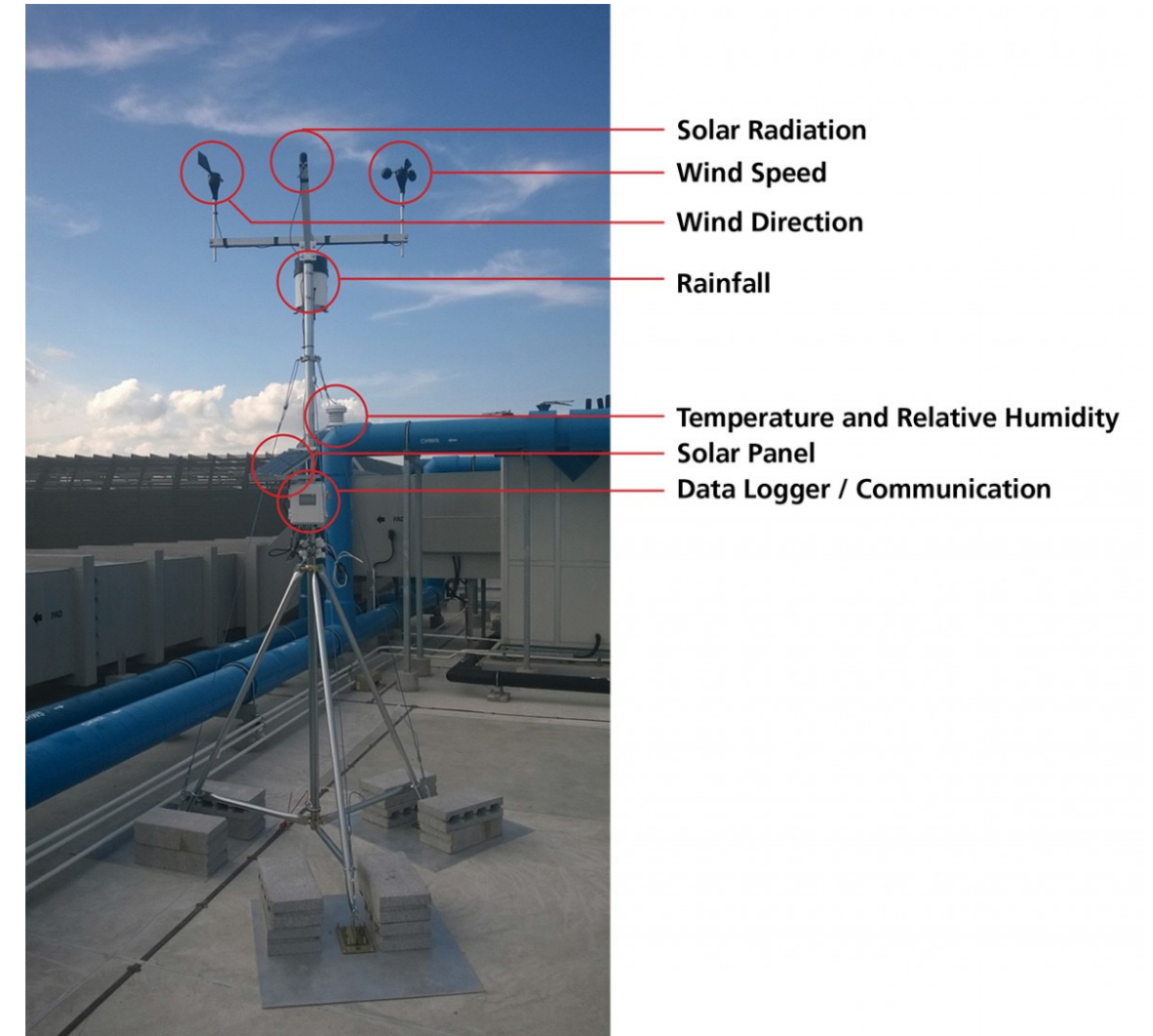
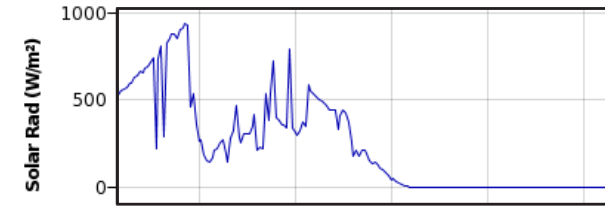
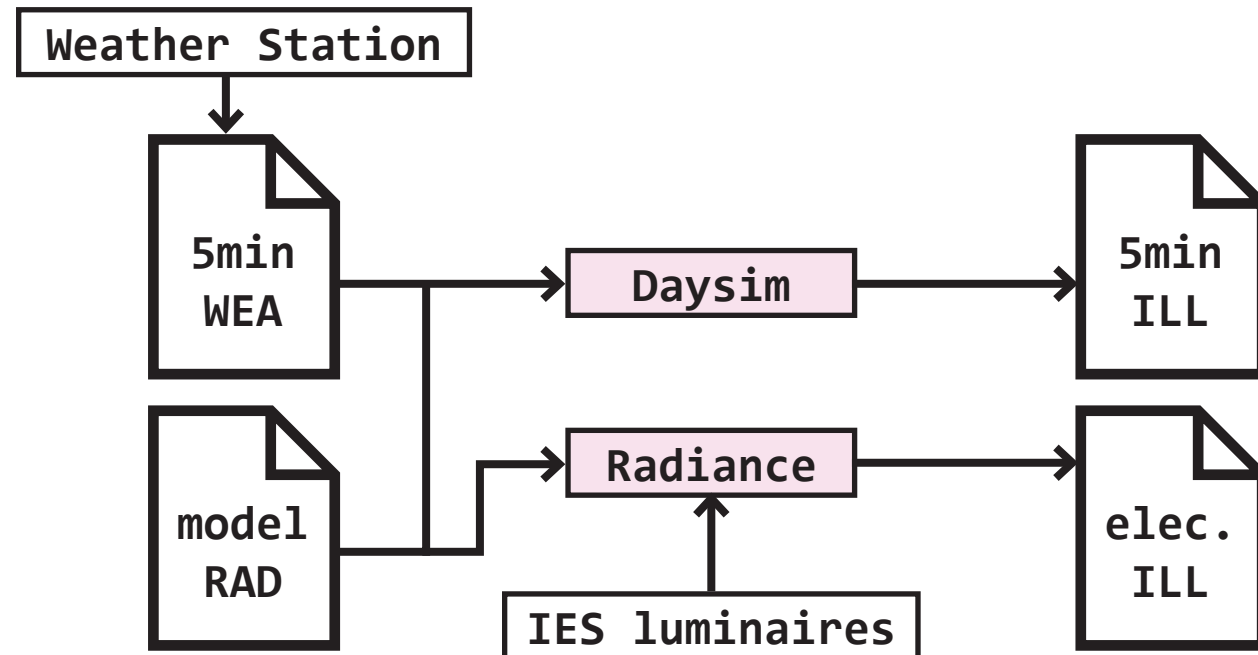

SUTD Weather Station



Local Validation and Error Checking

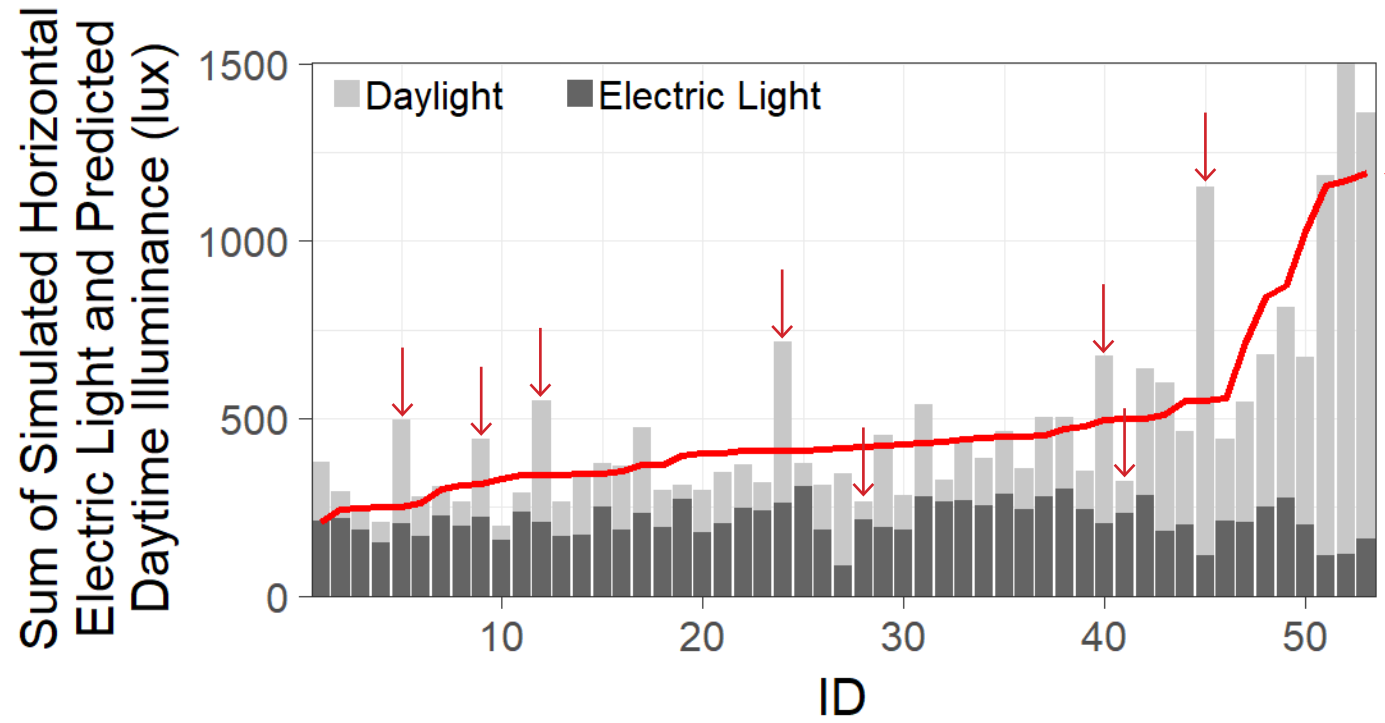

← Measured Illuminance Values

- Daylight illuminance values are extracted from the CDBM simulations dependent on the time of measurement.
- Individual measurements and building-level results are assessed for bias and errors.
- The model is adjusted accordingly to address faults.

Analysis of Simulated (Bars) and Measured (Red Lines) Horizontal Illuminance for One Office

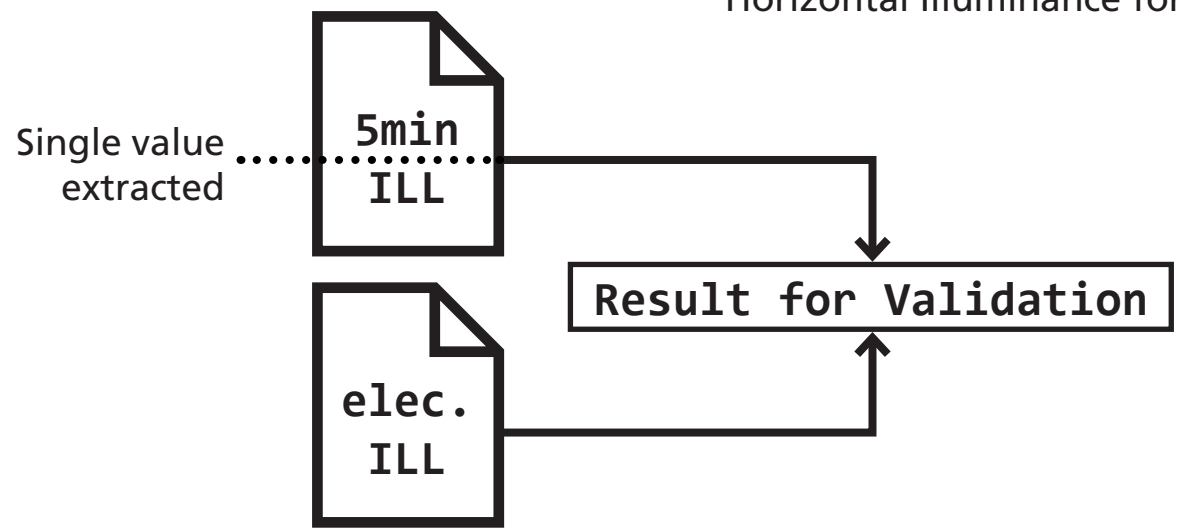

Overall Dataset Validation

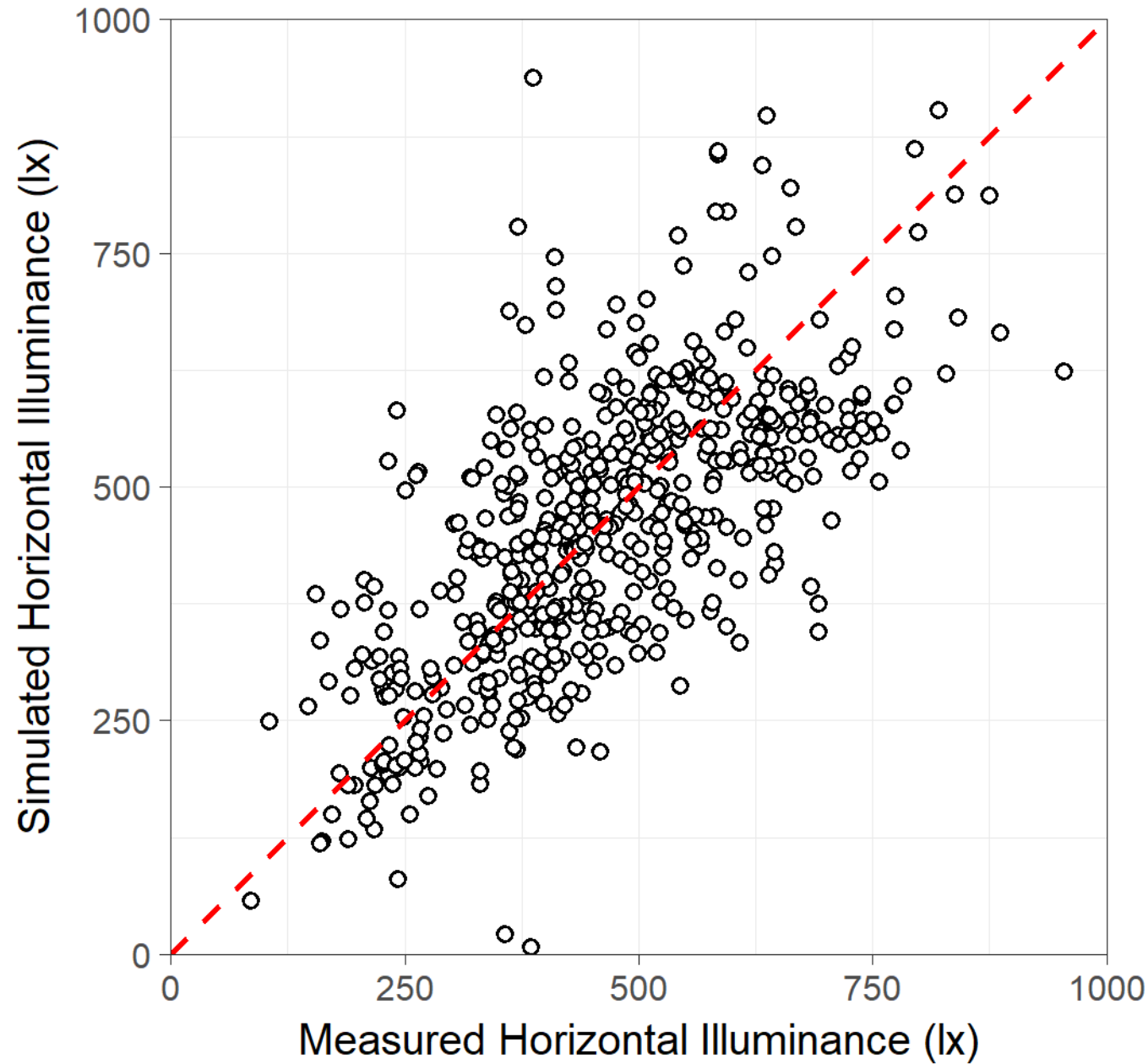

- n= 543 participants in 10 total office buildings
- RMSE= 25.8% of the mean measured value
- log10 RMSE = 4.3% of the mean measured value
- MBE = 0.3 lx
- These values fall short of the typical 20% goals espoused in lighting simulation validations; however, there are many issues present in calibrating models based on fieldwork.



- Distance to weather station
- Shading material properties
- Screen luminance and content
- Difficult to model desk clutter

Typical HDR Capture



10 Offices, 10 Simulation Models

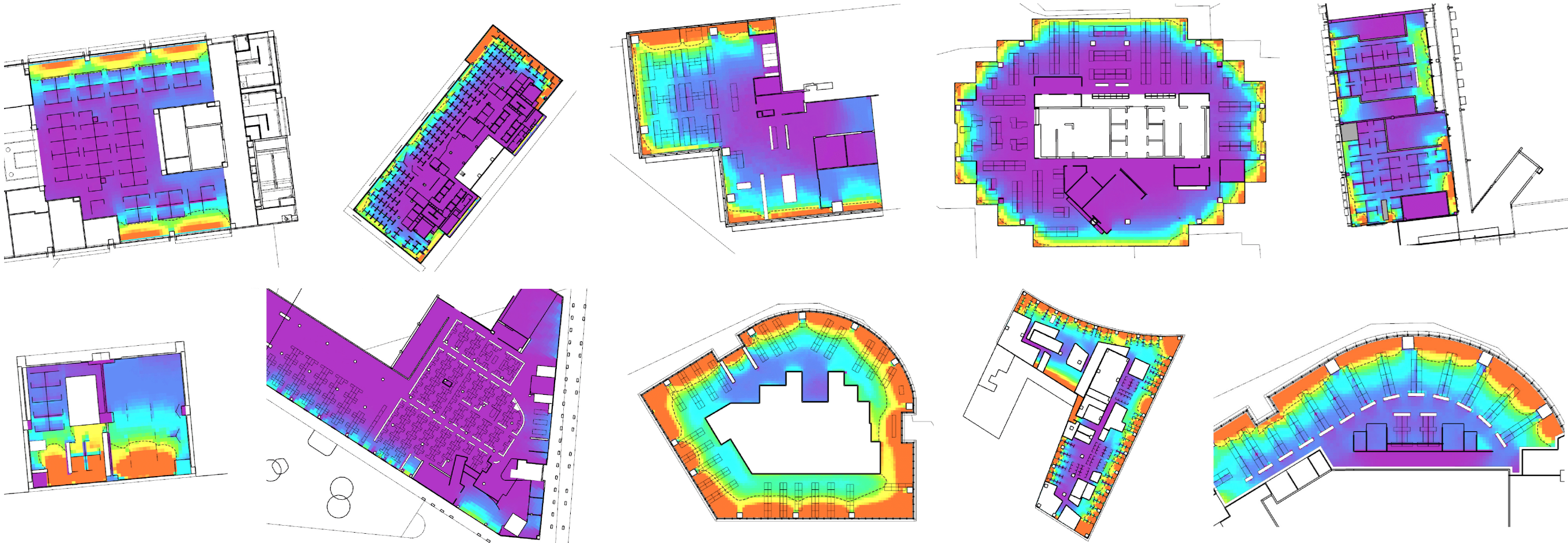

10 Offices, 10 Sets of Comprehensive Measurements (n= 543)

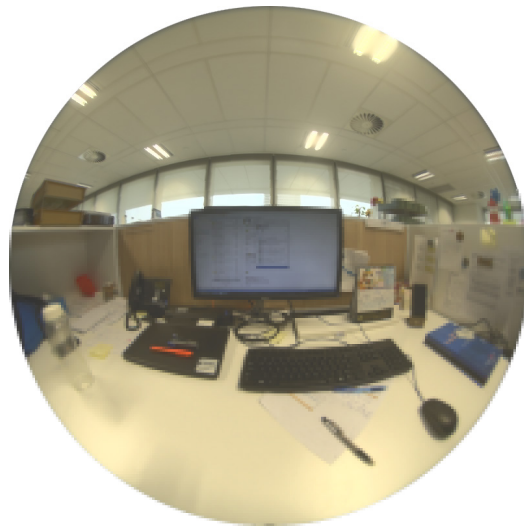

Resulting Data is Grouped by a Likely Predictor Variable

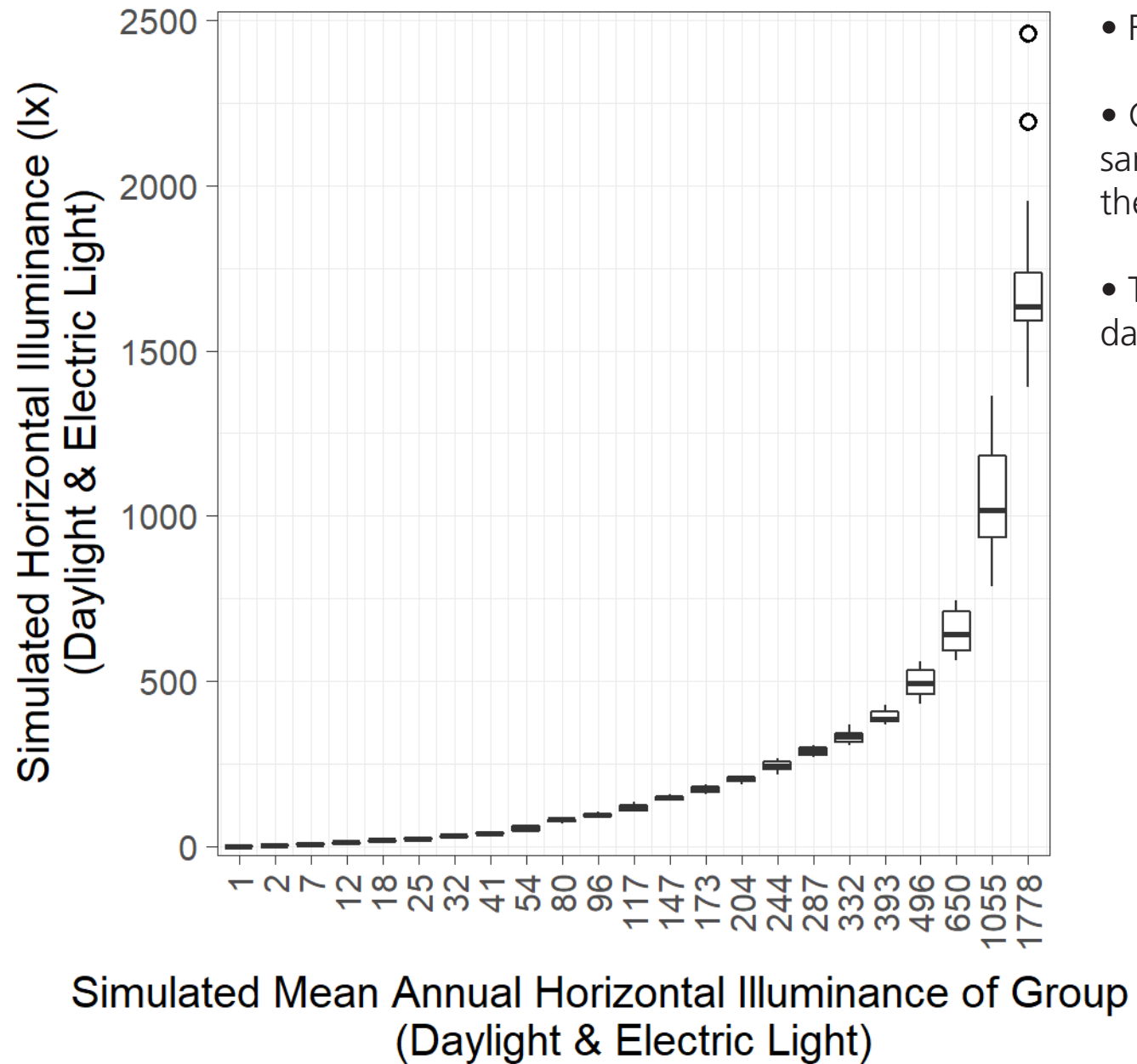

- First the data is grouped based on a predictor variable.
- Group number and size are always based on the square root of the sample size. $\sqrt{543} \approx 23$, so we have 23 groups based on quantile cuts of the predictor variable.
- The graph to the left shows a grouping based on the mean simulated daytime annual horizontal illuminance without shades.



Finally, Survey Data is Correlated with Simulated or Measured Results

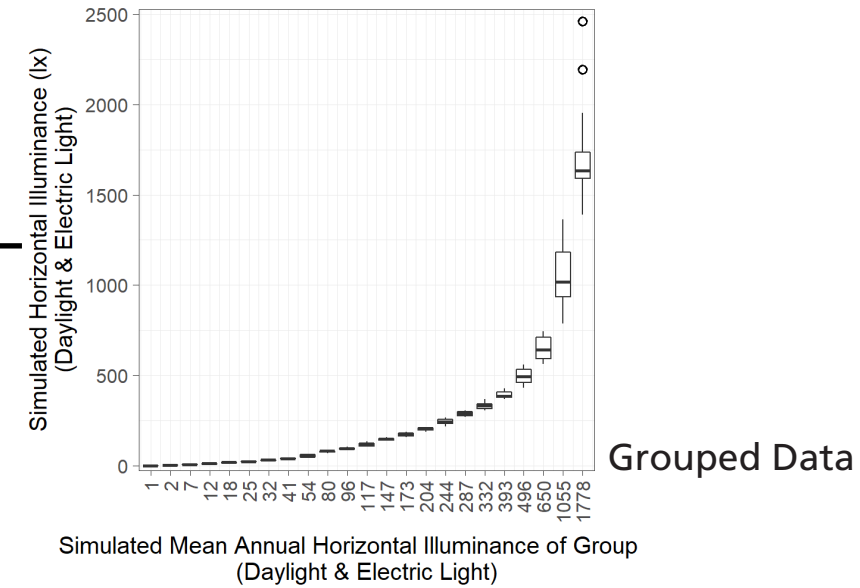
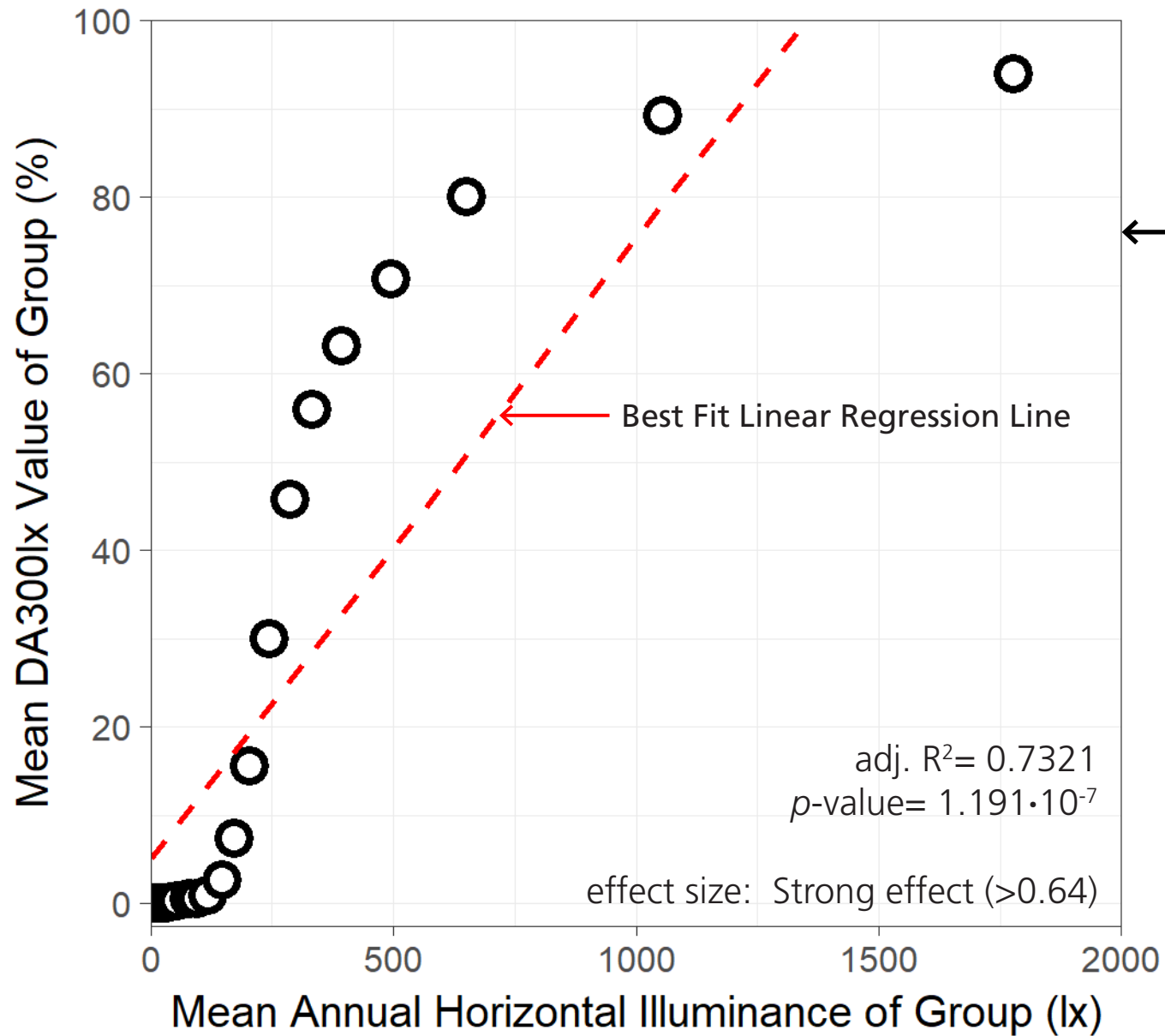

- Based on the grouped predictor variable, matching statistics from the rest of the data is computed per group.
- Simple regression analysis is applied in most cases. The adjusted R^2 (effect size) and p -value (probability of a false conclusion) are calculated.
- In the case shown to the left, mean horizontal illuminance and DA300lx percentages are paired, which have a nonlinear relationship.



Results



Satisfaction with Access to Daylight

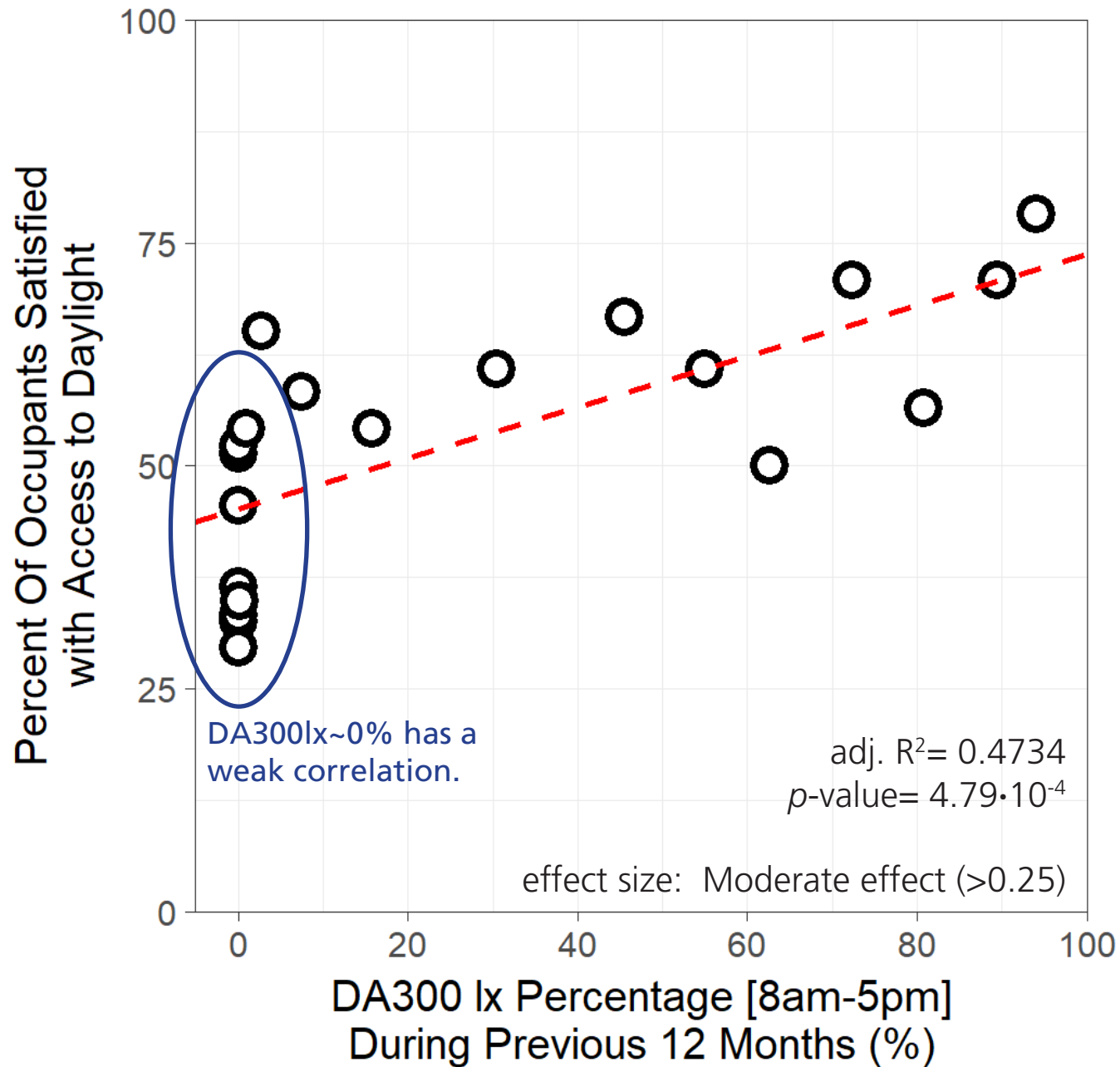

Question "How satisfied are you with your access to daylight?"
Responses "A little satisfied," "satisfied," or "very satisfied."
Predictor DA 300lx (%)

- DA 300lx values greater than 0% serve as a strong predictor of satisfaction with daylight access.
- Many participants (25-60%) are still satisfied with daylight access who have DA 300 lx values very close to 0% (see **blue** circled area).



Satisfaction with Access to Daylight

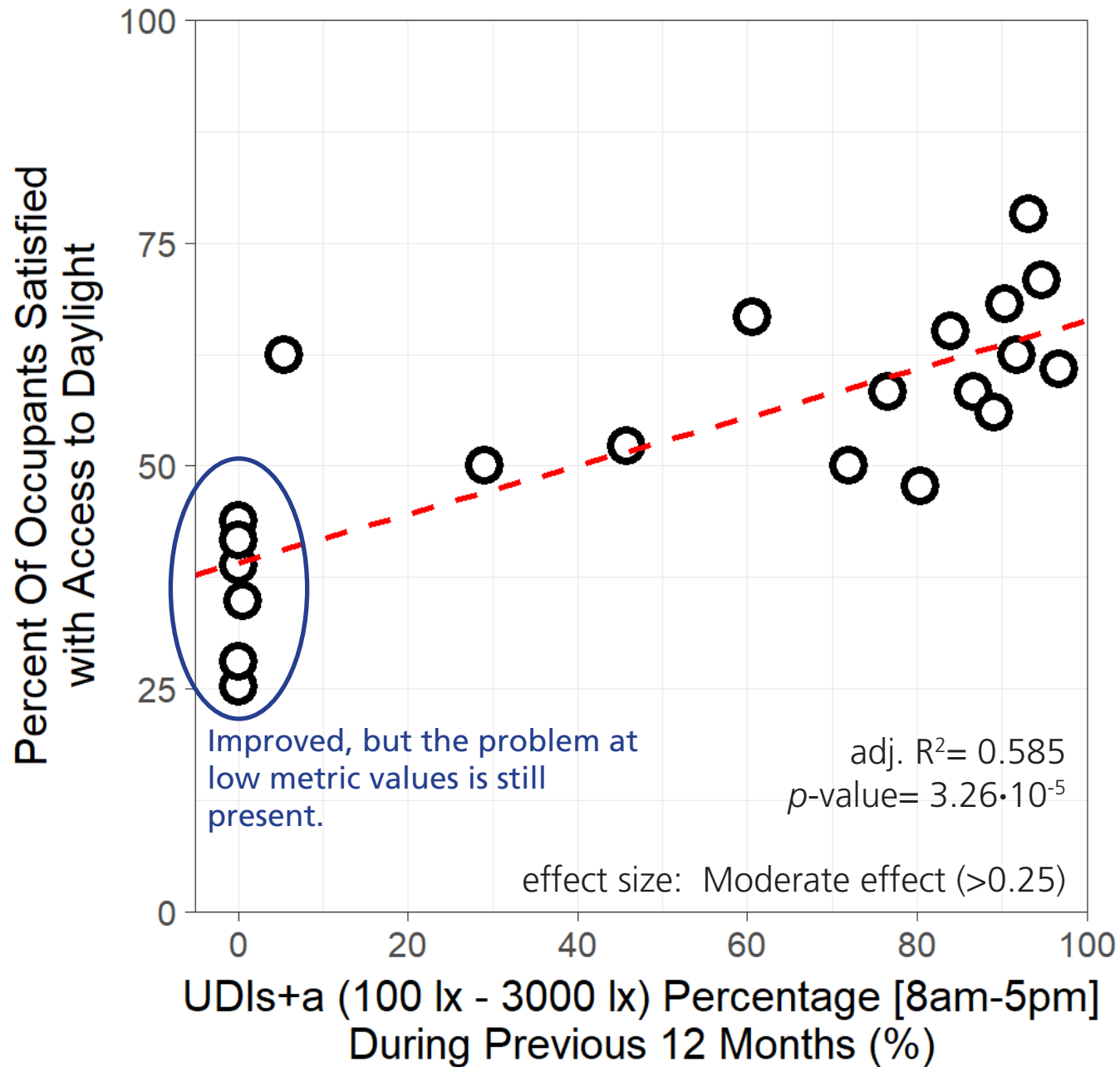

Question "How satisfied are you with your access to daylight?"
Responses "A little satisfied," "satisfied," or "very satisfied."
Predictor UDIs(100lx-300lx) + UDIa(300lx-3,000lx) (%)

- By using UDI supplemental + UDI autonomous and expanding the illuminance range considered to 100 lx - 3,000 lx, better results can be obtained.
- The same predictive issue in the **blue** circled area is still present however.
- In essence, a significant number of participants are still satisfied with daylight access even at very low daylight illuminance levels throughout the year.



Satisfaction with Access to Daylight

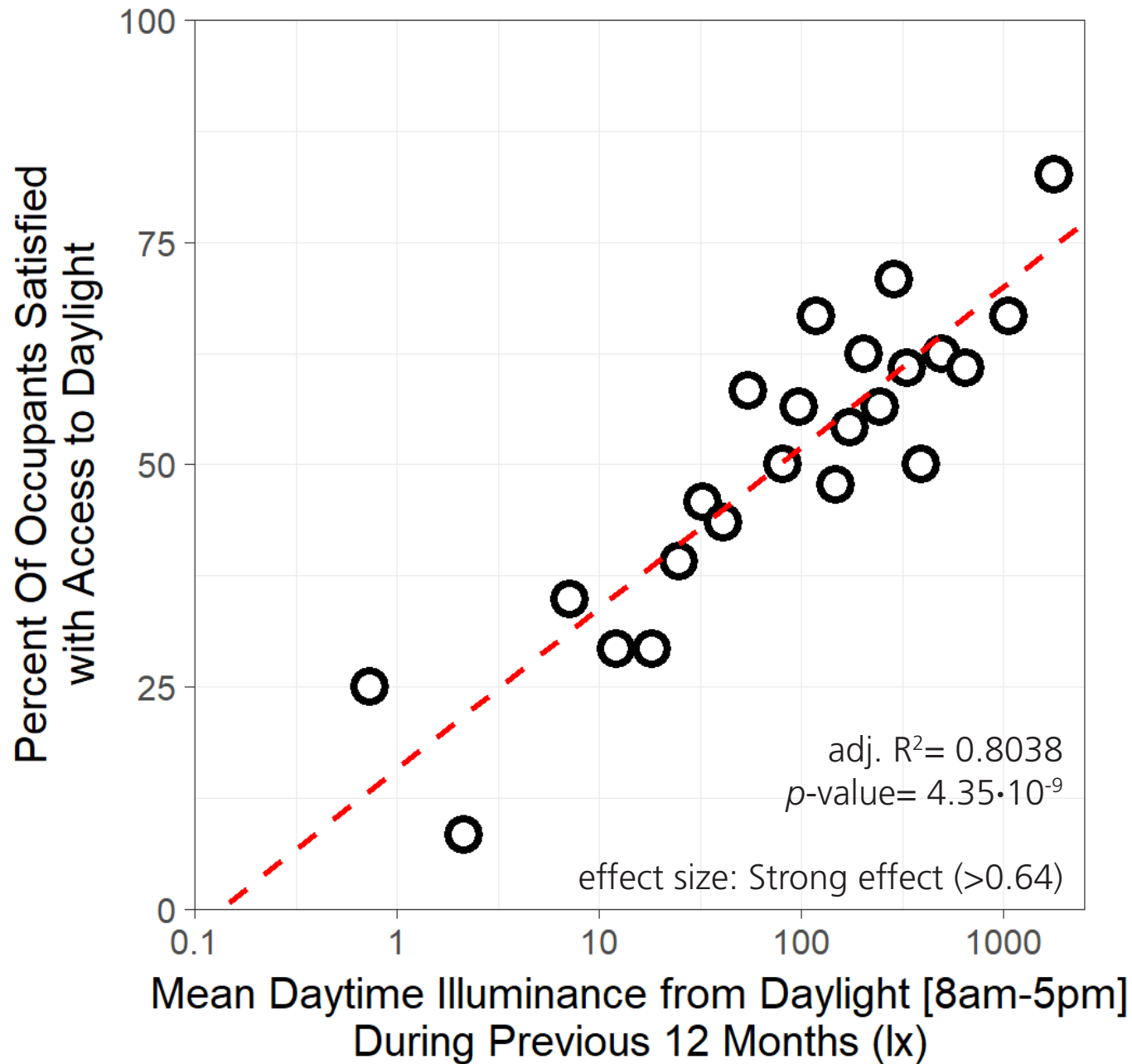

Question "How satisfied are you with your access to daylight?"
Responses "A little satisfied," "satisfied," or "very satisfied."
Predictor log10 Mean Annual Horizontal Illuminance (lx)

- Being a bit more direct, the mean annual illuminance values during the daytime (log10) can be correlated with satisfaction to daylight access, and the effect size is massive (adj. $R^2=0.8038$).
- The correlation with vertical eye illuminance simulations is, surprisingly, nearly identical (adj. $R^2= 0.8007$) where vertical illuminance might be thought to correlate better with perception.

$$\text{satisfaction, } s = 18.499 \cdot \log_{10}(E_{h_{\text{mean}}}) + 14.982$$

- Note: these simulations are performed with shades up, as in a normal design model.



Almost Naturally, Dissatisfaction with Daylight Access Is the Inverse

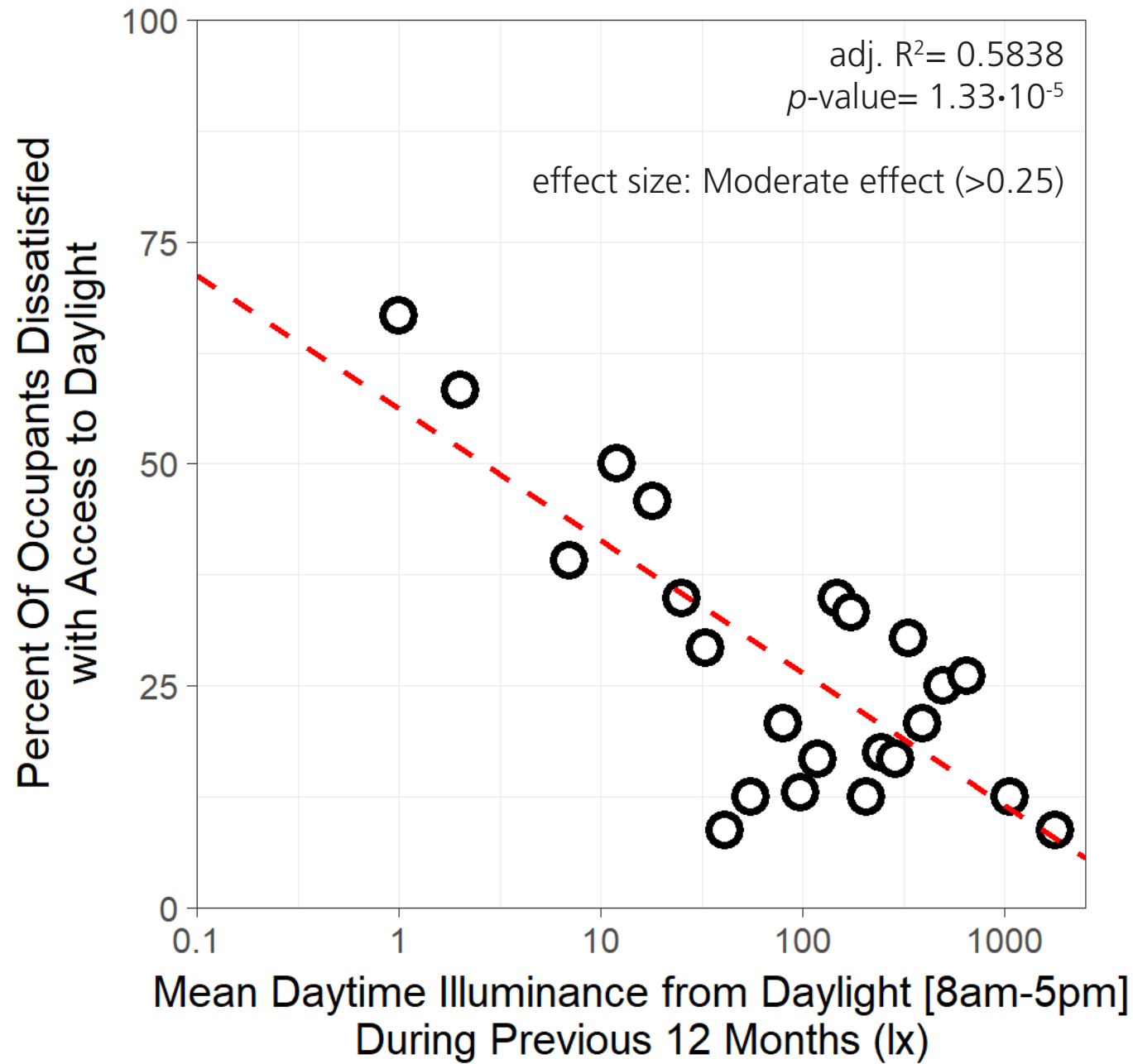

Question "How satisfied are you with your access to daylight?"
Responses "A little dissatisfied," "dissatisfied," or "very dissatisfied."
Predictor log10 Mean Annual Horizontal Illuminance (lx)

- With a bit more spread, long term dissatisfaction with access to daylight follows an inverted trend.



Example Applied to a Building in Singapore from our Dataset

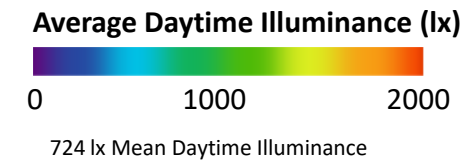
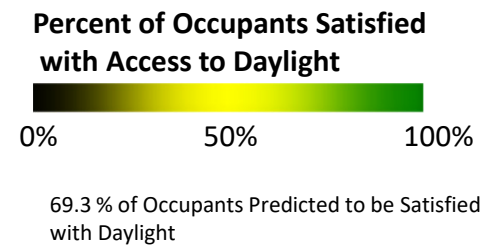
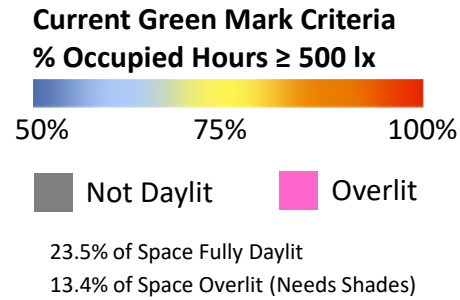
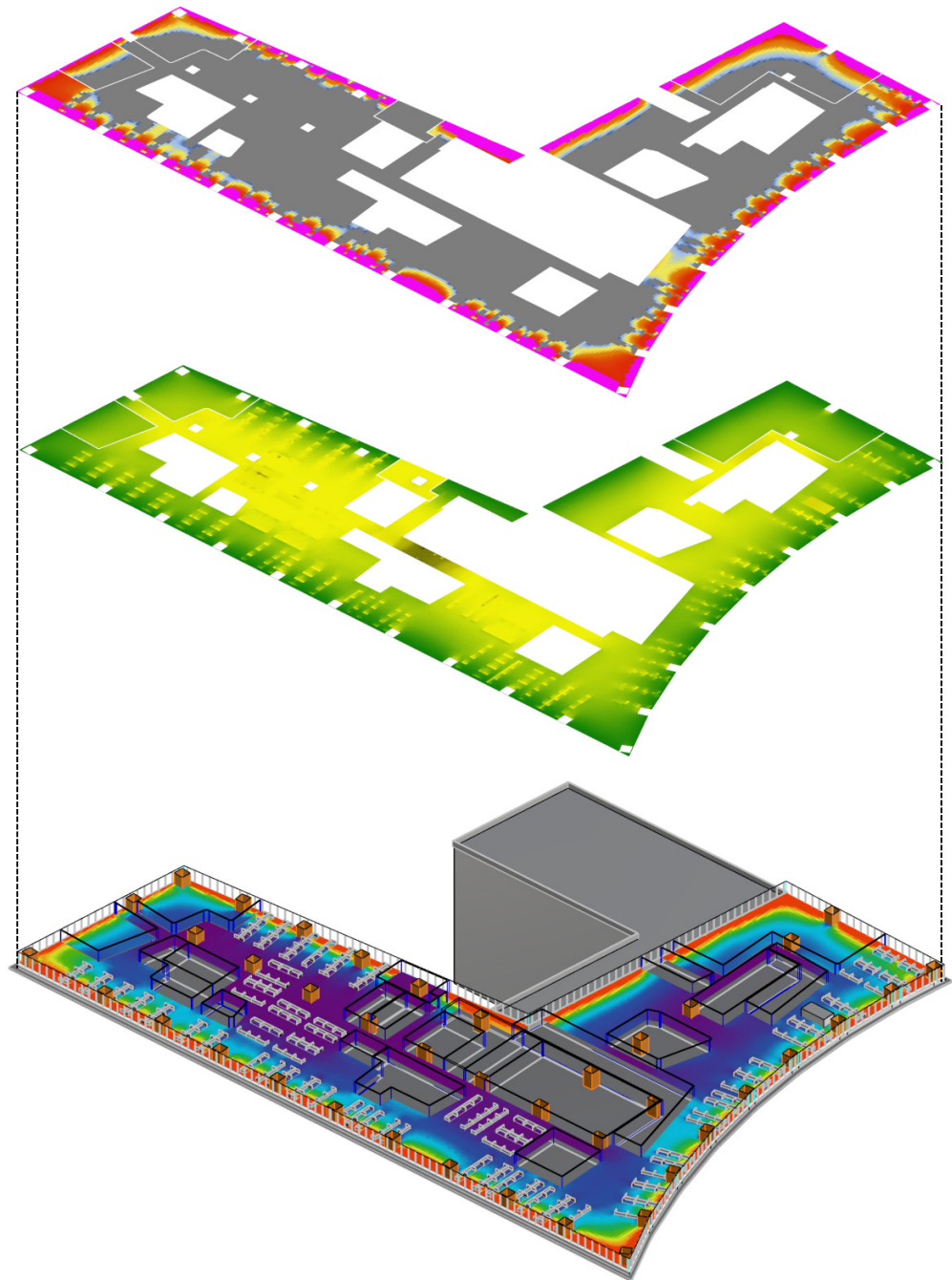

Daylighting in Singapore Project
Ascendas-Singbridge Offices

- The top result of this slide is based on the Singaporean daylighting standard. DA500lx,50% indicates daylit rather than the familiar 300lx,50% threshold.
- The disconnect between fully daylit to substantially eliminate electric lighting needs and subjective feelings of satisfaction is striking.
- At 80 lx mean daytime illuminance, ~50% of participants are predicted to be at least a little satisfied with their access to daylight and ~28% to be at least a little dissatisfied. The remainder are neutral.
- But it takes 1,750 lx mean daytime illuminance to result in ~75% of participants being predicted to feel at least a little satisfied. Only ~8% are predicted to feel dissatisfied at this lighting level.



The Trial of Predicting Long-term Discomfort Assessments

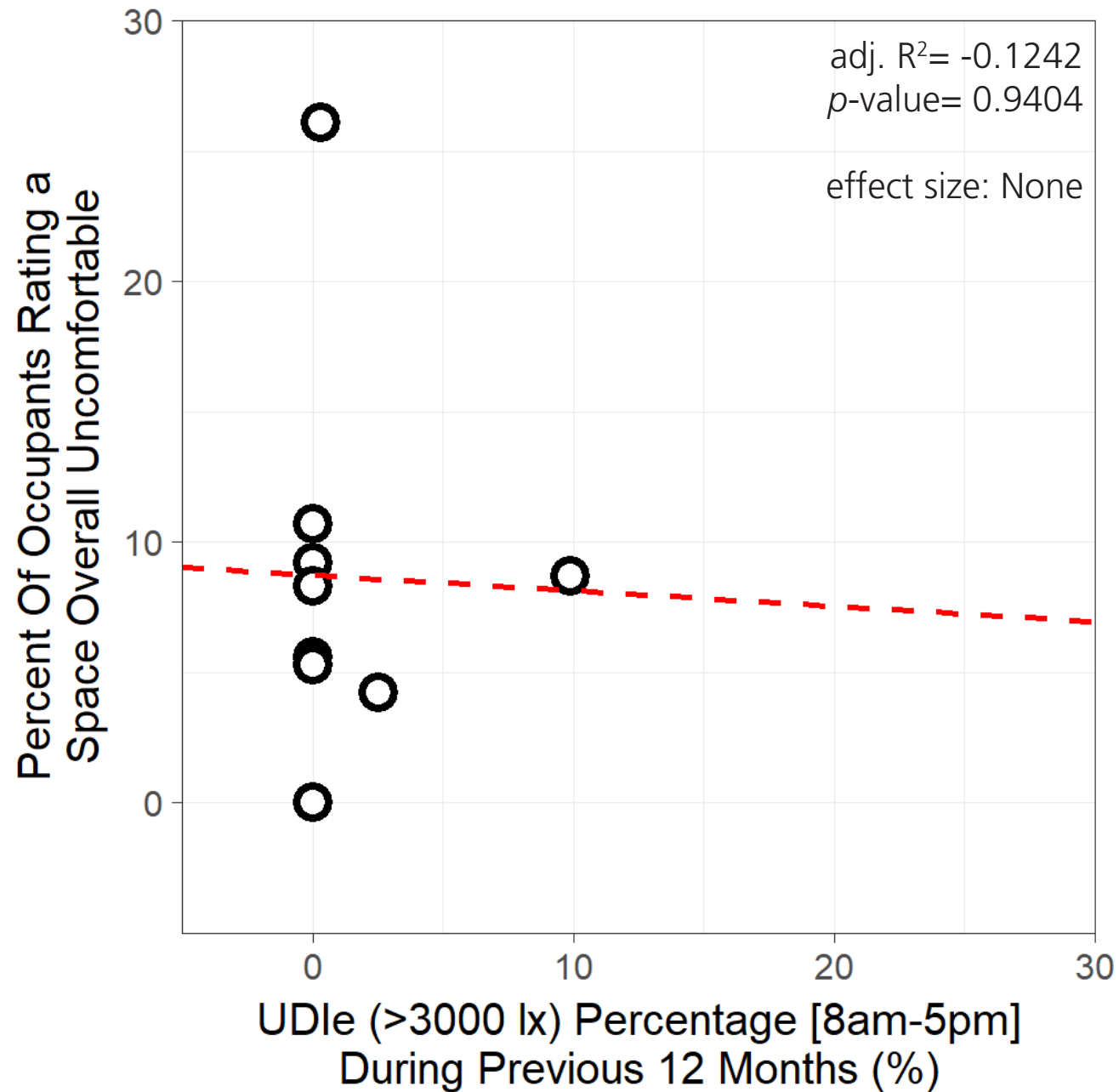

Question

“For the length of time you have been using this workspace, how do the combined lighting conditions from daylight and electric light make you feel?”

Responses

“A little uncomfortable,” “somewhat uncomfortable,” or “very uncomfortable.”

Predictor

UDle >3000lx (%)

- We did not ask participants to split their long-term assessment of comfort into electric and daylight causes.
- Therefore, it is difficult to directly apply daylight measures to the assessment of discomfort glare in this type of POE study.
- Another issue is simply that the open plan office spaces are very deep, and few participants experience 3,000 lx a significant amount of the time.
- Only 4.4% (24/543) of participants are predicted to experience 3,000 lx on their workplane more than 5% of the time without shades.



The Trial of Predicting Long-term Discomfort Assessments

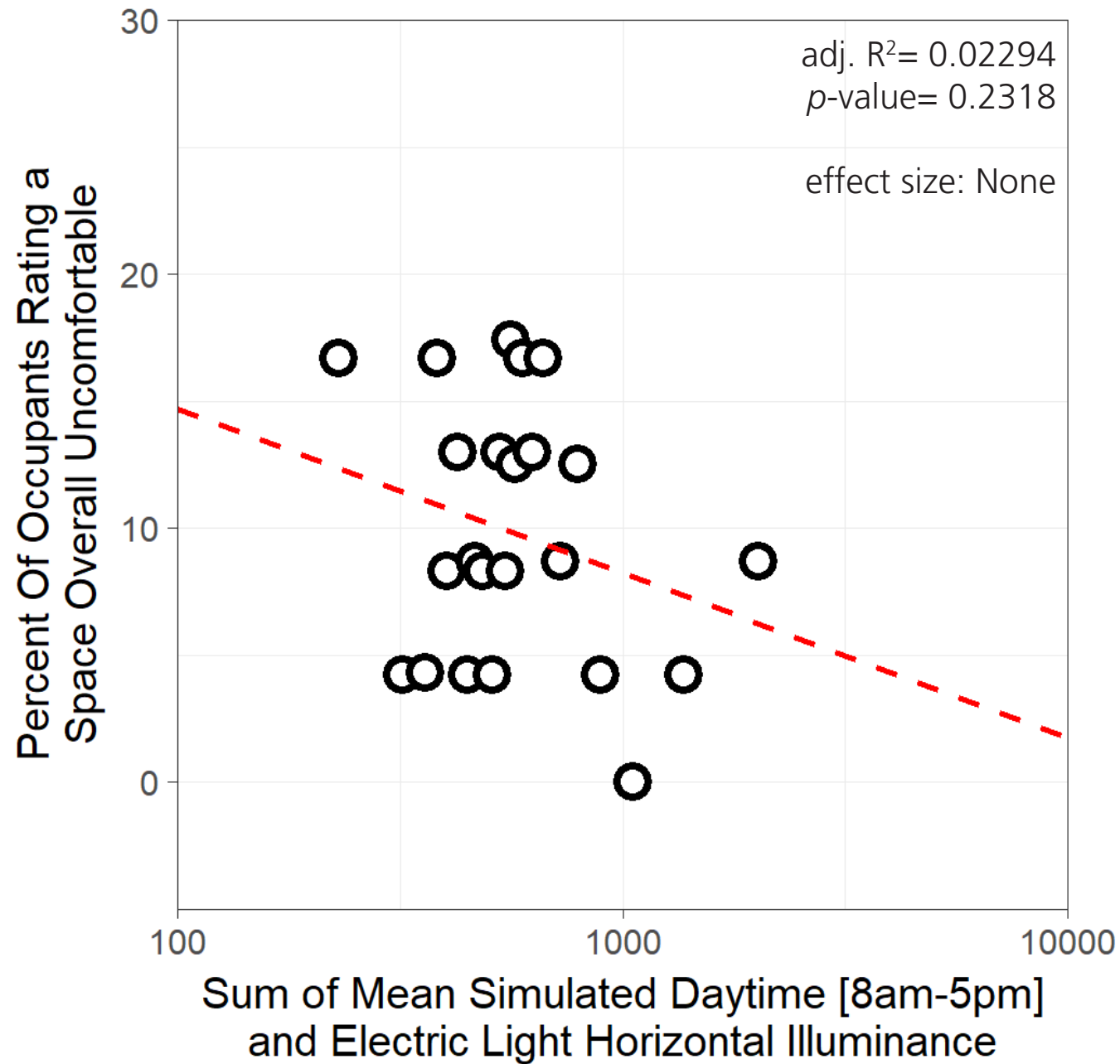

Question

“For the length of time you have been using this workspace, how do the combined lighting conditions from daylight and electric light make you feel?”

Responses

“A little uncomfortable,” “somewhat uncomfortable,” or “very uncomfortable.”

Predictor

mean daytime illuminance + electric light (lx)

- Being more direct by combining electric and daylight illuminance does not provide a better result.
- Switching to vertical light levels doesn't make a difference.



Going to the Source: Reported Causes of Discomfort from Occupants

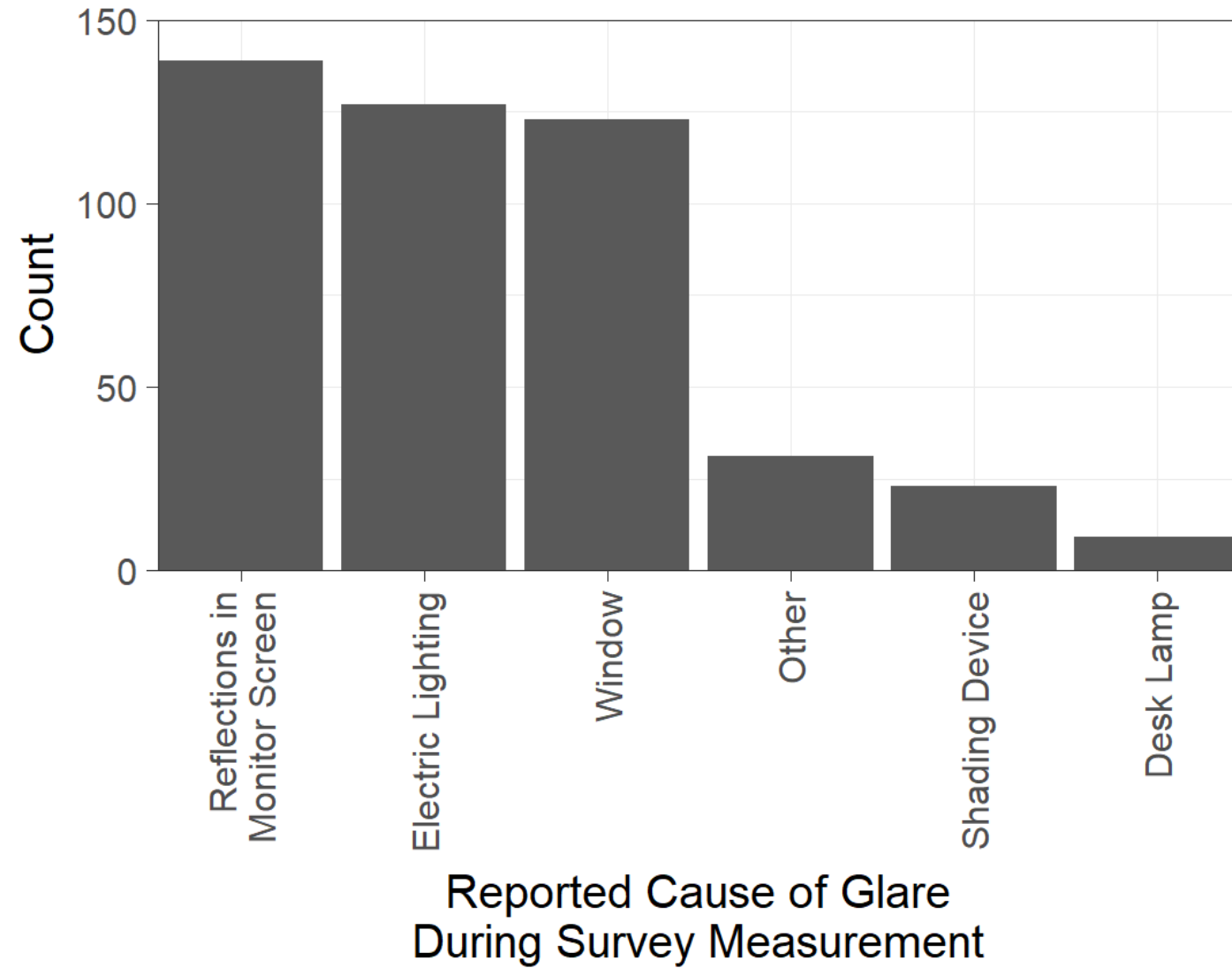

- Sometimes it is best to go to the source—occupant reported glare causes.
- From the instantaneous questions of our survey, glare was caused by reflections in the screen and electric lighting more than from window brightnesses.



Going to the Source: Reported Causes of Discomfort from Occupants

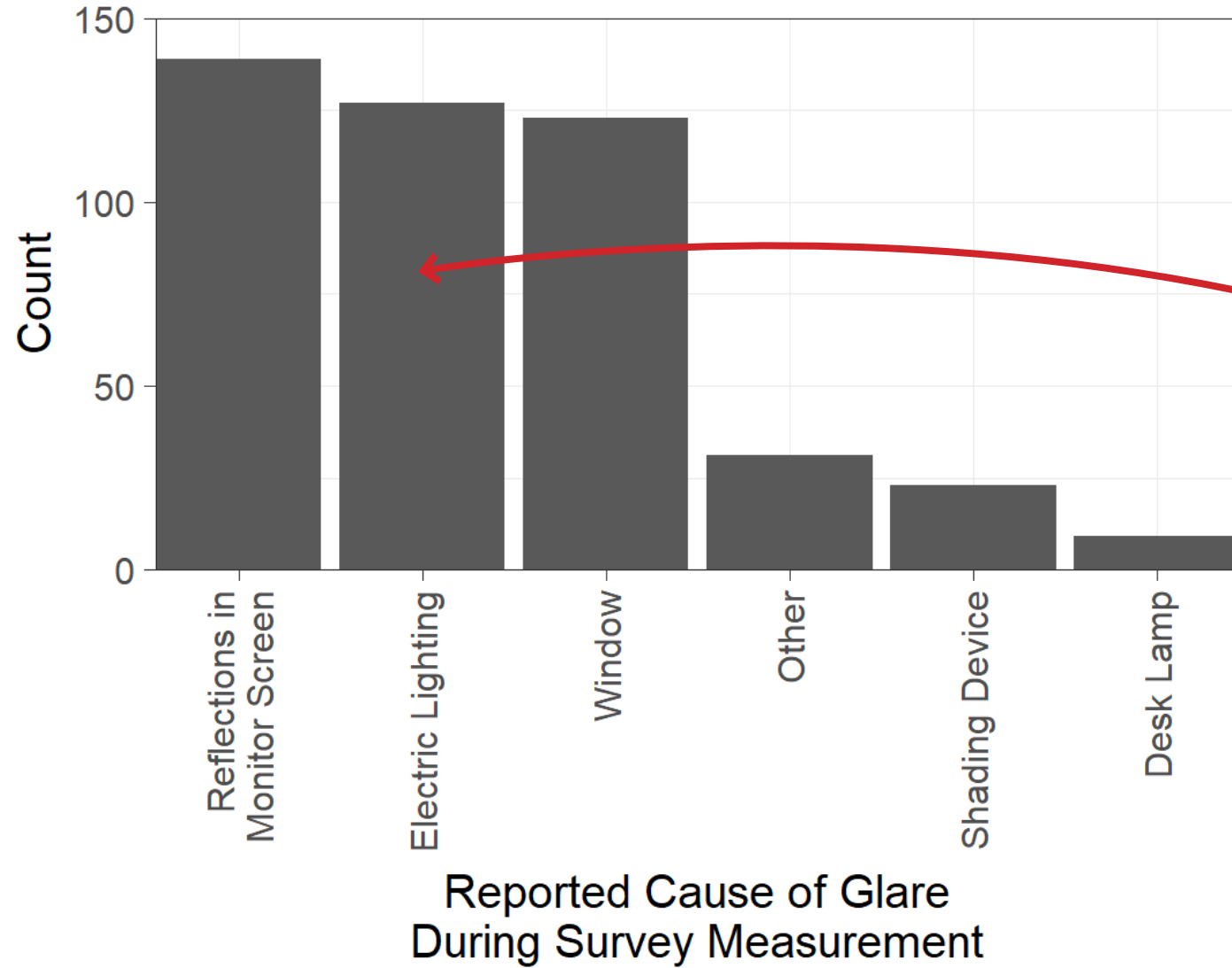

• But even Visual Comfort Probability (VCP) results look relatively comfortable from our measurements.

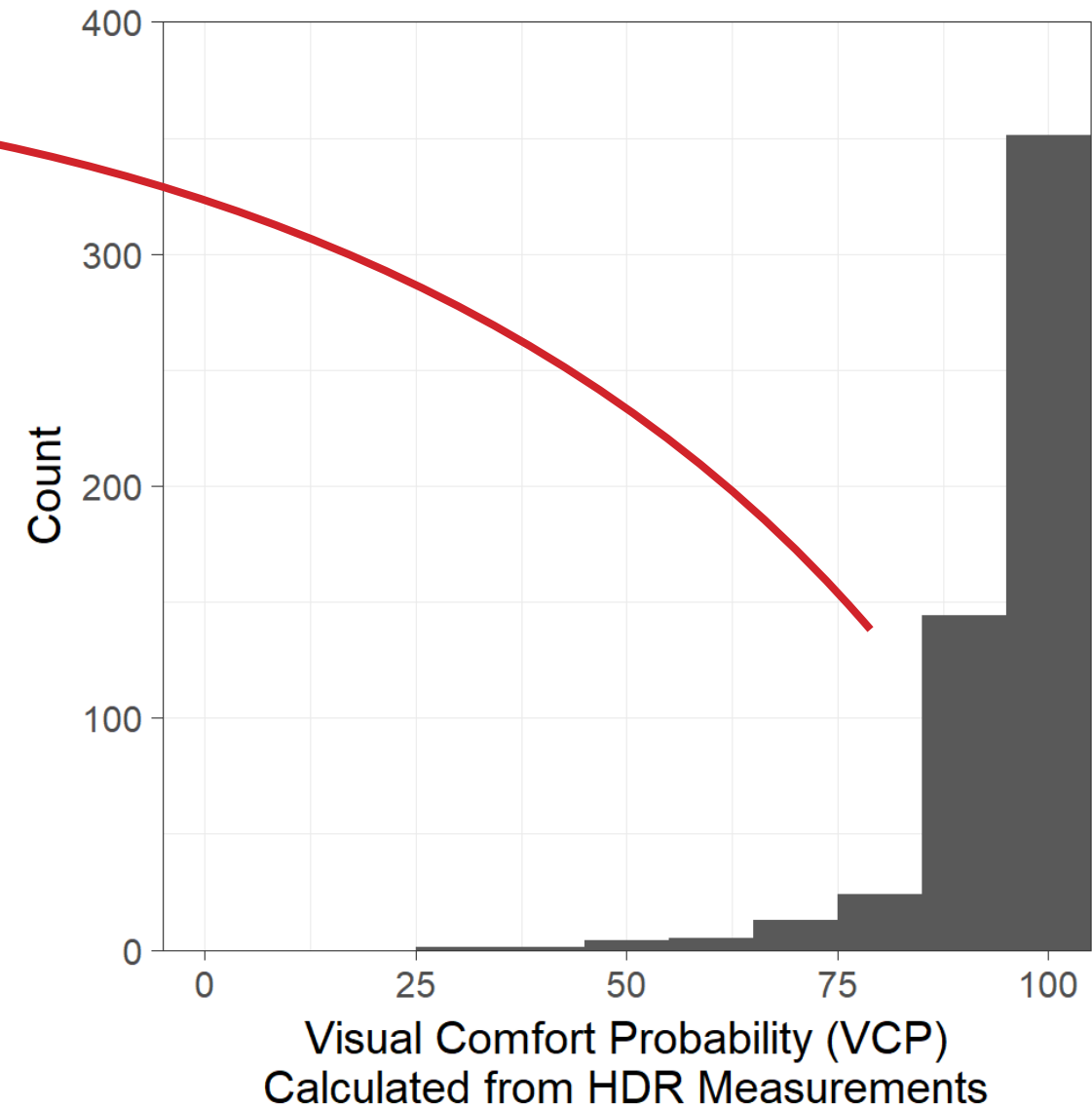

Anecdote About Reported Glare Sources

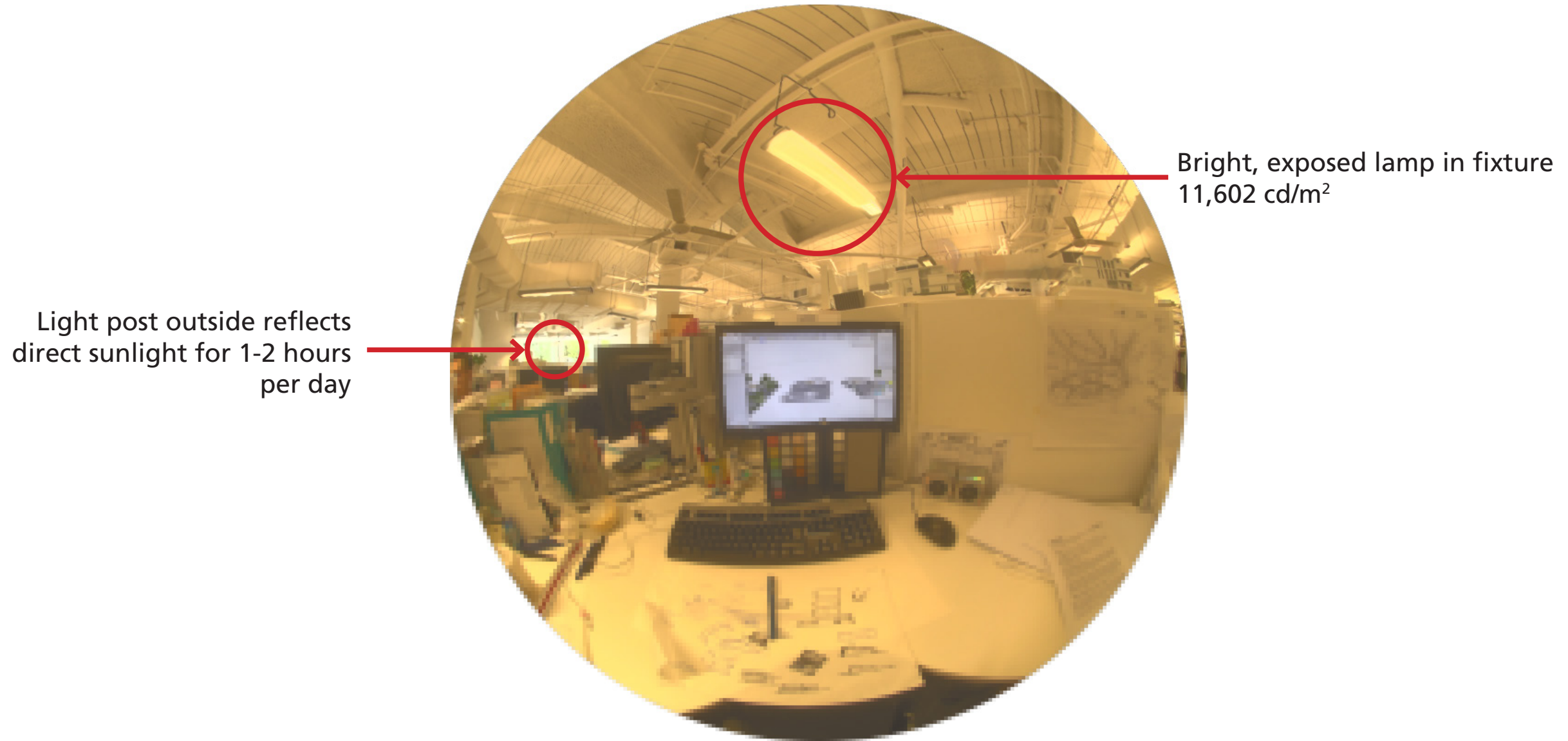

Participants often complain verbally and in the free-answer section of the survey about issues that normal simulations will not catch.



Estimating Lighting Design Criteria - 300 lx vs 500 lx

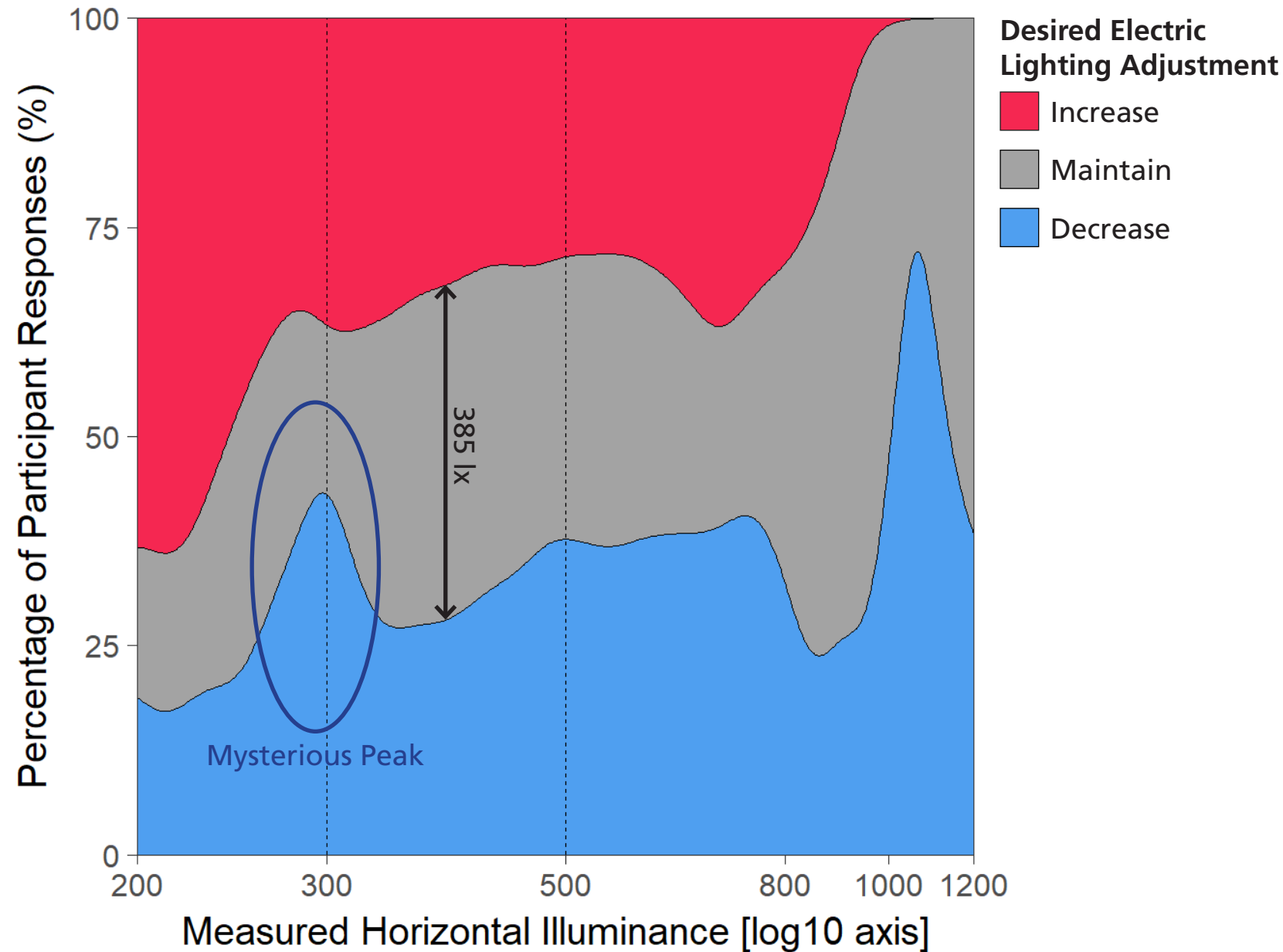

- An old goal: Can an argument be made for 300 lx over 500 lx? In Singapore this is a hard sell.
- A smoothed density plot (left) based on our instantaneous measurements and paired with the question, "How would you adjust electric lighting in this space to improve the current lighting environment?" gives an idea.
- Within the 300lx - 500 lx range, the highest percentage of 'maintain electric lighting levels' is found at a value of 385 lx, after which the desire to decrease lighting levels increases until ~700 lx.



Estimating Lighting Design Criteria - 300 lx vs 500 lx - CBDM Data

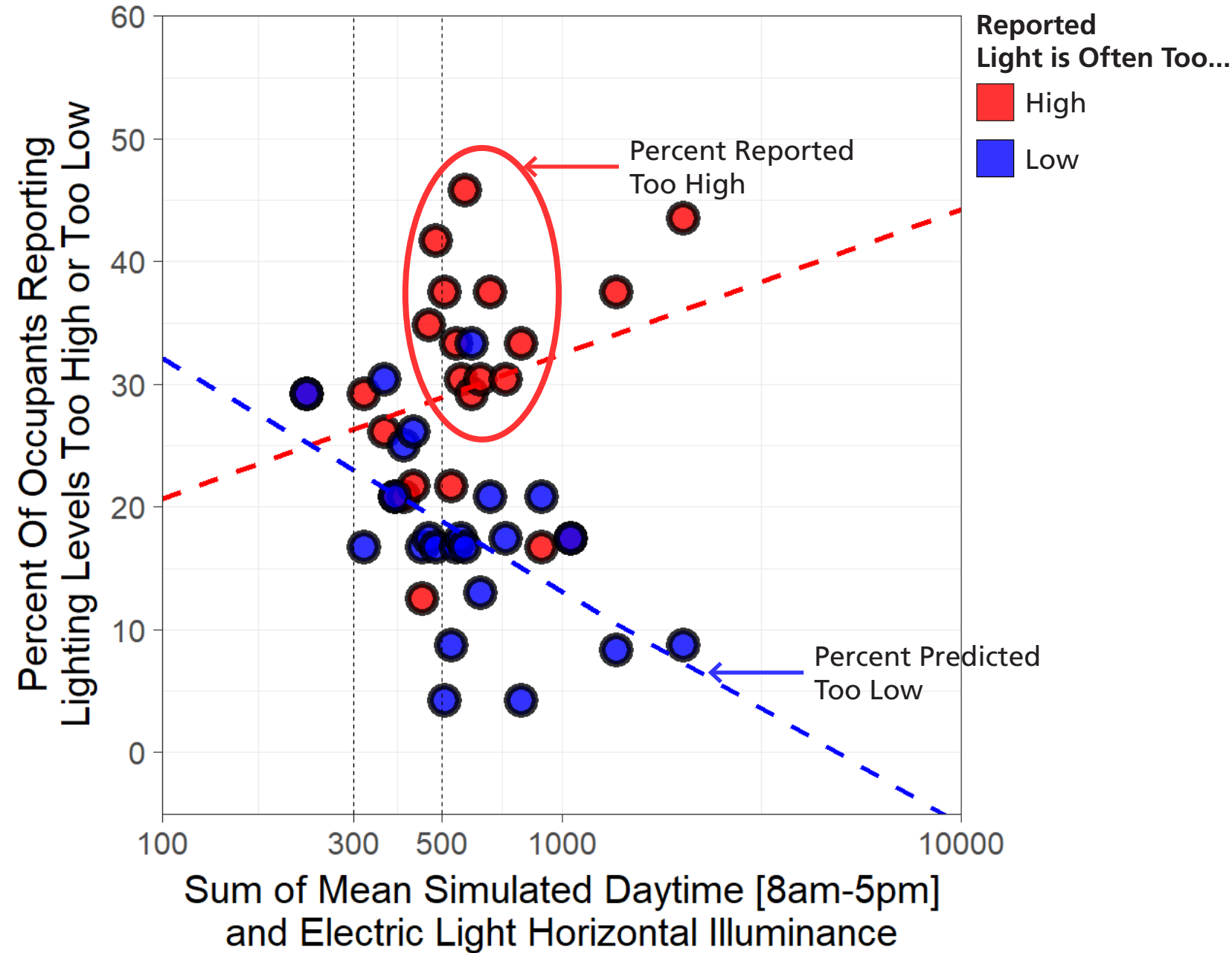

- There is high variance present in the responses to the prompts, "The total amount of light from daylight and electric lighting systems in this space is often too high / too low."
- However, the red circled region reveals that the cluster of points between 400lx - 700 lx has a significant number of participants reporting that the lighting levels are too high.
- On the other hand, there are marginally more 'too low' results between 200 lx - 300 lx.



Estimating Lighting Design Criteria - 300 lx vs 500 lx

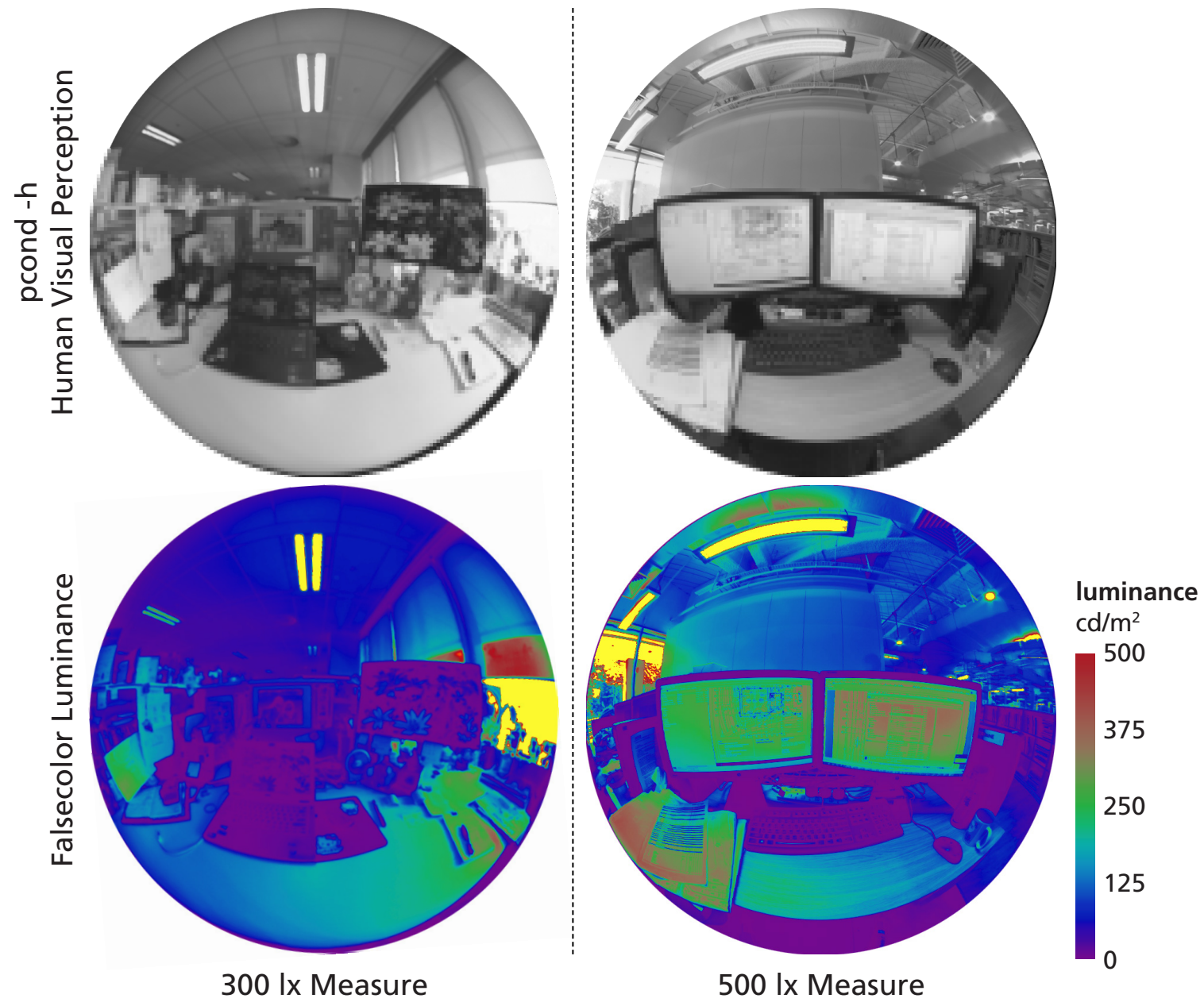

- But overall... participants in our study just can't tell the difference between 300 lx and 500 lx of horizontal workplane illuminance so easily.
- This is not surprising.
- So choose 300 lx.



Conclusions

- Climate-based daylighting metrics do relate to how occupants feel about real daylit spaces; however, lower levels ($< 100\text{lx}$) of supplemental light exposure are underrepresented in current CBDM's.
- We created a new measure, satisfaction with access to daylight based on 543 surveys and calibrated lighting models in Singapore.
- Visual discomfort is terribly difficult to predict in the field.
- There is decent evidence to support lighting design criteria of 300 lx based on instantaneous measurements and CBDM simulations of spaces.



Future Work

- Annual luminance-based discomfort simulations are running for all 543 participants in the study using a 5-minute time interval.
- We are recreating this study for 80 participants in a laboratory setting in order to compare results.
- Multivariate analysis for discomfort criteria based on participant-identified glare causes.



Towards Subjectivity in Annual Climate-Based Daylight Metrics

J. Alstan Jakubiec¹

asd.sutd.edu.sg/dcc

spectraldb.com

john_jakubiec@sutd.edu.sg

Geraldine Quek^{1,2}

Thanyalak Srisamranrungruang^{1,3}

1. Singapore University of Technology and Design

2. École Polytechnique Fédérale de Lausanne

3. Meiji University

Thank you!

Work supported by:

1. National Research Foundation, Prime Minister's Office, Singapore Research, Innovation & Enterprise (RIE) Funding's Green Buildings Innovation Cluster (GBIC) program Grant number GBIC-R&D / DCP 05

2. SUTD-MIT International Design Centre (IDC)

